



Leading Conversion Technology for Power Resilience

# BRAVO 25 - 48/120

## User Manual V1.0

### BEYOND THE INVERTER

THE NEW GENERATION OF POWER CONVERTERS

- **DUAL INPUT INVERTER**  
Commercial Power as default source
- **AC BACKUP IN A DC ENVIRONMENT**  
Leverage your existing DC infrastructure
- **ONE STOP SHOP**  
Wide output power range
- **HARSHEST AC INPUT CONDITIONS**  
Without compromising the quality of the AC output

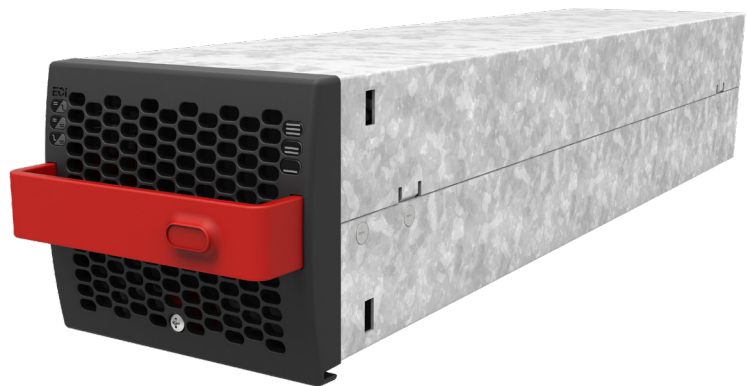

Copyright © 2022. Construction electroniques & telecommunications S.A.  
All rights reserved. The contents in document are subject to change without notice.  
The products presented are protected by several international patents and trademarks.  
Address: CE+T S.a, Rue du Charbonnage 12, B 4020 Wandre, Belgium  
www.cet-power.com - info@cet-power.com

 [www.cet-power.com](http://www.cet-power.com)

 Belgium, China, India, Luxembourg, Malaysia, Russia, United Kingdom, United States, Australia & Germany

# Table of Contents

1. Introduction to CE+T .....	6
2. Abbreviations .....	7
3. Warranty and Safety Conditions .....	8
3.1 Disclaimer .....	8
3.2 Technical care .....	8
3.3 Installation .....	9
3.3.1 Handling .....	9
3.3.2 Surge and transients .....	9
3.3.3 Other .....	9
3.4 Maintenance .....	10
3.5 Replacement and Dismantling .....	10
4. ECI TECHNOLOGY .....	11
4.1 On-line Mode .....	12
4.2 Safe mode .....	12
4.3 EPC-mode .....	12
4.4 Mix mode & Walk-in mode .....	12
5. Building Blocks .....	13
5.1 Inverter .....	13
5.2 Sub-rack .....	13
5.3 Controller - Inview S .....	14
5.3.1 Inview S - Connections .....	14
6. Accessories .....	15
6.1 Cabinet .....	15
6.2 Manual By-Pass .....	15
6.3 AC Distribution Unit .....	16
6.3.1 Miniature Circuit Breakers .....	16
6.3.2 MCCB .....	16
7. System Design .....	17
7.1 A la Carte .....	17
8. Installation of Bravo ECI Shelf .....	18
8.1 Mounting kit for Bravo ECI shelf .....	18
8.2 Electrical installation for Bravo Shelf .....	19
8.2.1 Pre requisites .....	19
8.2.2 Terminations .....	20
8.2.3 Grounding .....	20
8.2.4 DC Input .....	20
8.2.5 AC Input .....	20
8.2.6 AC Output .....	21
8.2.7 Signalling .....	21

8.2.8	Remote ON/OFF.....	21
8.2.9	Internal bus (ECI Bus 6 pin / ECI Bus 8 pin).....	22
8.2.10	Rear cover.....	22
<b>9.</b>	<b>Installation of Cabinet (A la Carte) .....</b>	<b>23</b>
9.1	Unpacking the system .....	23
9.2	Module packing.....	23
9.3	Removing the cabinet rear protection .....	24
9.4	Electrical installation .....	24
9.4.1	Positioning .....	25
9.4.2	Cabling.....	25
9.4.3	Grounding .....	26
9.4.4	Surge Suppression .....	26
9.4.5	AC Input (X2) .....	26
9.4.6	DC Input (X1).....	27
9.4.7	Connection Table – AC Input (X2) & Output (X4) for 48 Vdc version.....	29
9.4.8	Connection Table DC Input 48 VDC (X1).....	29
9.4.9	Signalling .....	30
<b>10.</b>	<b>Interface .....</b>	<b>32</b>
10.1	Inverter module.....	32
10.2	Inview S - LCD interface.....	33
10.2.1	LED indications .....	33
10.2.2	Menu structure.....	34
10.3	Inview S and Inview S Slot - Web Interface .....	35
10.3.1	Login.....	35
10.3.2	Interface Areas .....	35
<b>11.</b>	<b>Inserting/removing/replacing - modules.....</b>	<b>38</b>
11.1	ECI Inverter .....	38
11.1.1	Removal.....	38
11.1.2	Inserting.....	38
11.2	Inview S.....	39
11.2.1	Panel Mounting .....	39
11.3	Fan replacement .....	40
<b>12.</b>	<b>AC Output Distribution.....</b>	<b>41</b>
12.1	Miniature Circuit breaker Installation/Removal.....	41
12.2	MCCB.....	41
<b>13.</b>	<b>Manual By-Pass (MBP).....</b>	<b>42</b>
13.1	Pre-requisites.....	42
13.2	MBP Auxiliary connection .....	42
13.3	Manual Bypass operation .....	43
13.3.1	MBP - Single rotary switch.....	43
13.3.2	MBP - Three individual switches.....	44

14. Finishing .....	45
15. Commissioning .....	46
15.1 Check list.....	47
16. Trouble Shooting and Defective Situations Fixing.....	48
16.1 Trouble Shooting .....	48
17. Maintenance.....	49
17.1 Access Inview S with Laptop .....	49
17.2 Manual check.....	49
17.3 Optional .....	49
17.4 Manual By-Pass .....	49
18. Defective modules .....	50
19. Service .....	51
20. Appendix.....	52
20.1 Mains connection, Single phase .....	52
20.2 Mains connection, Three phases.....	53
20.3 Bravo ECI - Dimensions.....	54
20.3.1 Module.....	54
20.3.2 Shelf .....	54
20.4 Inview S with MBB - Wiring diagram.....	55
20.5 Modules - Parameter List .....	56

Release Note:

Version	Release date (DD/MM/YYYY)	Modified page number	Modifications
1.0	29/06/2022	-	First release of the manual

# 1. Introduction to CE+T

---

CE+T Power designs, manufactures, and markets a range of products for industrial operators, with mission critical applications, who are not satisfied with existing AC backup system performances and related maintenance costs.

Our product is an innovative AC backup solution that unlike most used UPS's

- Maximizes the operator's applications uptime;
- Operates with lowest OPEX;
- Provides best protection to disturbances;
- Optimizes footprint.

Our systems are:

- Modular
- Truly redundant
- Highly efficient
- Maintenance free
- Battery friendly

CE+T power puts 60+ years expertise in power conversion together with worldwide presence to provide customized solutions and extended service 24/7 - 365 days per year.

## 2. Abbreviations

---

AC	Alternating current
DC	Direct current
DHCP	Dynamic Host Configuration Protocol
DSP	Digital Signal Processor
ECI	Enhanced Conversion Innovation
EPC	Enhanced Power Conversion
ESD	Electro Static Discharge
ETH	Ethernet
HTTP	HyperText Transfer Protocol
HTTPS	Secure HyperText Transfer Protocol
LAN	Local Access Network
MBB	Measure Box Battery
MBP	Manual By-pass
MET	Main Earth Terminal
MIB	Management Information Base
N	Neutral
NTP	Network Time Protocol
NUA	Non-Urgent Alarm
PCB	Printed Circuit Board
PE	Protective Earth (also called Main Protective Conductor)
PWR	Power
REG	Regular
SNMP	Simple Network Management Protocol
TCP/IP	Transmission Control Protocol/Internet Protocol
TRS	True Redundant Structure
UA	Urgent Alarm
USB	Universal Serial Bus

## 3. Warranty and Safety Conditions\*

### WARNING:

The electronics in the power supply system are designed for an indoor, clean environment.

When installed in a dusty and/or corrosive environment, outdoor or indoor, it is important to:

- Install an appropriate filter on the enclosure door, or on the room's air conditioning system.
- Keep the enclosure door closed during operation.
- Replace the filters on a regular basis.

### Important Safety Instructions and Save These Instructions.

#### 3.1 Disclaimer

- The manufacturer declines all responsibilities if equipment is not installed, used or operated according to the instructions herein by skilled technicians according to local regulations.
- Warranty does not apply if the product is not installed, used and handled according to the instructions in the manuals.

#### 3.2 Technical care

- This electric equipment can only be repaired or maintained by a "qualified employee" with adequate training. Even personnel who are in charge of simple repairs or maintenance are required to have knowledge or experience related to electrical maintenance.
- Please follow the procedures contained in this Manual, and note all the "DANGER", "WARNING" AND "NOTICE" marks contained in this Manual. Warning labels must not be removed.
- Qualified employees are trained to recognize and avoid any dangers that might be present when working on or near exposed electrical parts.
- Qualified employees know how to lock out and tag out machines so the machines will not accidentally be turned on and injure employees working on them.
- Qualified employees also know safety related work practices, including those by OSHA and NFPA, as well as knowing what personal protective equipment should be worn.
- All operators are to be trained to perform the emergency shut-down procedure.
- Never wear metallic objects such as rings, watches, or bracelets during installation, service and maintenance of the product.
- Insulated tools must be used at all times when working with live systems.
- When handling the system/units pay attention to sharp edges.

\* These instructions are valid for most CE+T Products/Systems. Some points might however not be valid for the product described in this manual



### 3.3 Installation

- This product is intended to be installed only in restricted access areas as defined by UL60950 and in accordance with the National Electric Code, ANSI/NFPA 70, or equivalent agencies.
- The Inverter System may contain output over current protection in the form of circuit breakers. In addition to these circuit breakers, the user must observe the recommended UL listed upstream and downstream circuit breaker requirements as defined in this manual.
- Please use extreme caution when accessing circuits that may be at hazardous voltages or energy levels.
- The modular inverter rack is a dual input power supply. The complete system shall be wired in a way that both input and output leads can be made power free.
- REG systems and EPC systems that have no AC input wired and connected can be seen as independent power sources. To comply with local and international safety standards N (output) and PE shall be bonded. The bonded connection between N (output) and PE must be removed once the AC input is connected.
- AC and DC circuits shall be terminated with no voltage / power applied.
- The safety standard IEC/EN62040-1-1 requires that, in the event of an output short circuit, the inverter must disconnect in 5 seconds maximum. The parameter can be adjusted on Inview; however, if the parameter is set at a value > 5 seconds, an external protection must be provided so that the short circuit protection operates within 5 seconds. Default setting is 60 seconds.
- The system is designed for installation within an IP20 or IP21 environment. When installed in a dusty or humid environment, appropriate measures (air filtering) must be taken.
- All illustrations in the manual are for general reference, refer to the technical drawing which is received along with the system for exact information.

#### 3.3.1 Handling

- The cabinet shall not be lifted using lifting eyes.
- Remove weight from the cabinet by unplugging the inverters. Mark inverters clearly with shelf and position for correct rebuild. This is especially important in dual or three phase configurations.
- Empty inverter positions must not be left open. Replace with module or cover.

#### 3.3.2 Surge and transients

The mains (AC) supply of the modular inverter system shall be fitted with Lightning surge suppression and Transient voltage surge suppression suitable for the application at hand. Manufacturer's recommendations of installation shall be adhered to. Selecting a device with an alarm relay for function failure is advised.

Indoor sites are considered to have a working lightning surge suppression device in service.

- Indoor sites Min Class II.
- Outdoor sites Min Class I + Class II or combined Class I+II. The modular inverter system/rack can reach hazardous leakage currents. Earthing must be carried out prior to energizing the system. Earthing shall be made according to local regulations.

#### 3.3.3 Other

- Isolation test (Hi-Pot) must not be performed without instructions from the manufacturer.

### 3.4 Maintenance

- The modular inverter system/rack can reach hazardous leakage currents. Earthing must be carried out prior to energizing the system. Earthing shall be made according to local regulations.
- Prior to any work conducted on a system/unit make sure that AC input voltage and DC input voltage are disconnected.
- Inverter modules and shelves contain capacitors for filtering and energy storage. Prior to accessing the system/modules after power down, wait at least 5 minutes to allow capacitors to discharge.
- Some components and terminals carry high voltage during operation. Contact may result in fatal injury.

### 3.5 Replacement and Dismantling

- ESD Strap must be worn when handling PCB's and open units.
- CE+T cannot be held responsible for disposal of the Inverter system and therefore the customer must segregate and dispose of the materials which are potentially harmful to the environment, in accordance with the local regulations in force in the country of installation.
- If the equipment is dismantled, to dispose of its component products, you must comply with the local regulations in force in the country of destination and in any case avoid causing any kind of pollution.

To download the latest documentation and software, please visit our website at [www.cet-power.com](http://www.cet-power.com)

## 4. ECI TECHNOLOGY <sup>1</sup>

Inverter modules carrying the ECI logo and the EPC mark are triple port converters (AC in, DC in, AC out). Sinusoidal output is converted from Mains or/and DC.

The block diagram below gives an explicit description of the topology and operation.

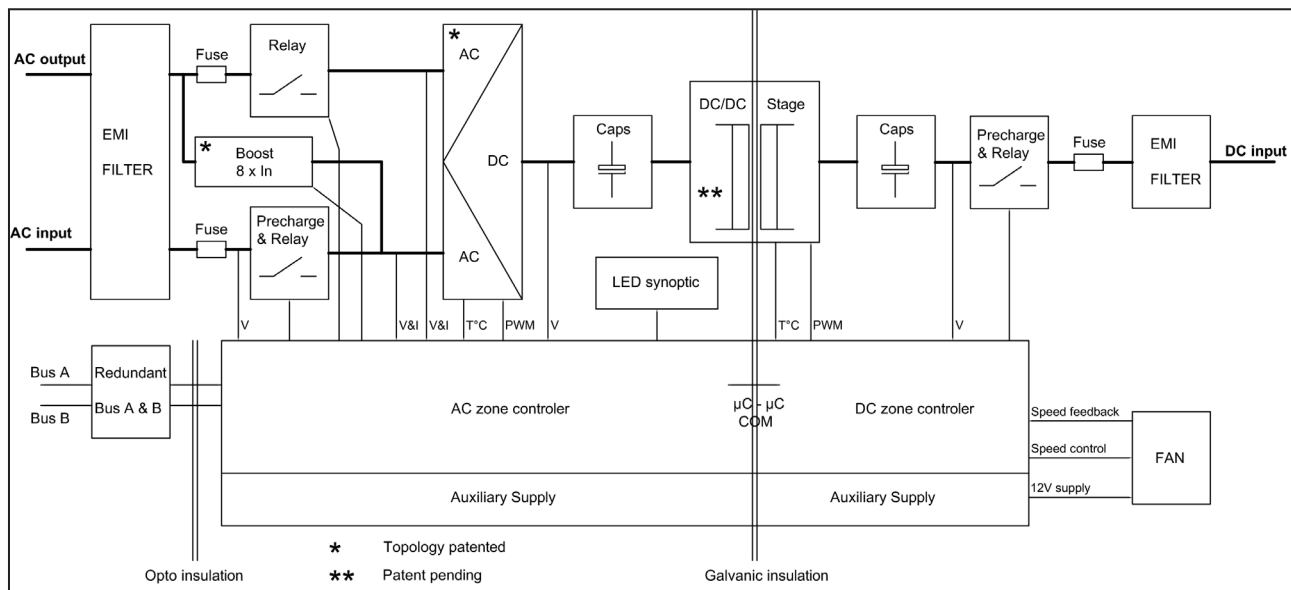

The module is built around the following sub-converters

- AC to DC at input
- DC to DC at input
- DC to AC at output

The energy can flow either from the AC source or the DC source under the control of the local DSP controller. Thanks to internal energy buffering, the output sine wave is constant and disturbance free regardless of the active source.

The BOOST functionality multiplies the nominal current for a period of 20 ms (max) in the event of down stream failures. The upstream breakers do not have to be oversized to prevent tripping. The overload capacity is 125% for 15 seconds.

The ECI works according to True Redundant Structure (TRS) that features decentralized and independent logic, redundant communication bus and three internal levels of disconnection to isolate a module after internal failure.

This functionality is included in every inverter module. Running them in parallel provides a modular system with, no single point of failure, always-conditioned output, high system efficiency and 0 ms source transfer time.

<sup>1</sup> Information and data given in this chapter is intended to serve as an overview of the ECI Technology. Detailed features and parameters for each individual module type in the range may differ and should be referred to in the dedicated data sheet.

## 4.1 On-line Mode

DC is the primary source of supply whilst Mains (AC) works as the secondary source. Switching time between DC input and AC input is 0 ms (source transfer). The power delivered by the DC source (usually a battery, but possibly any other type of DC generator) is converted to provide regulated and transient-free power to the load. In the event of a short circuit on the load side, the boost is automatic, timely and energized for a specific duration to trip downstream protective devices.

## 4.2 Safe mode

Safe mode uses DC as the primary source of supply while Mains (AC) is on standby.

Mains (AC) is normally disconnected through an internal inlet relay and is only connected when down stream clearance is required (boost) or if DC is unavailable.

The transfer between DC and AC results in a typical transfer time of 10 ms.

Typically the safe mode is used in extremely harsh environments such as railways. Under such conditions, it provides extra isolation against mains-borne disturbances.

## 4.3 EPC-mode

Mains input (AC) is the primary source whilst DC works as backup.

The ECI is designed to operate on Mains on a permanent basis and to deliver output voltage conditioned with low THD.

The output sine wave is physically independent of whether the source is AC (or) DC. If the Mains is out of tolerance or goes down, the converter seamlessly switches to DC and the converter operates in "Back-up mode" (Changeover switching time is 0 ms).

As soon as the Mains returns to its valid range, the EPC mode is automatically resumed.

The EPC mode offers higher efficiency (up to 96% depending on the model) without compromising the purity of the output sine wave.

### Remarks: REG modules:

Inverter modules carrying the ECI logo together with the REG mark work only with DC input. Sinusoidal output is converted from DC with the module operating as a traditional inverter. EPC mode and the boost are not available with REG modules.

## 4.4 Mix mode & Walk-in mode

Under some circumstances the DC and AC sources can be combined. The sequence is defined by a user selectable set of parameters. Start, control and exit are fully automatic.

A specific example of Mix-mode is the Walk-in mode where the transfer from DC source to AC source is ramped up within a fixed and adjustable period of time.

## 5. Building Blocks

### 5.1 Inverter

Telecom / Datacom:	Input	48 Vdc 120 Vac, 50/60 Hz
	Output	120 Vac
	Power	2750 VA / 2250 W

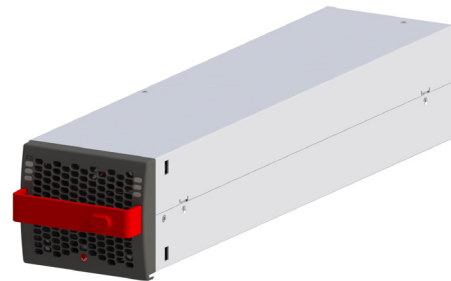

- The Bravo ECI is a 2750 VA / 2250 W triple port inverter.
- The Bravo ECI inverter modules are hot swappable and hot pluggable.
- The module operator interface is LEDs showing Inverter status and output power.
- The inverter modules is equipped with soft start.
- Fan is equipped with alarm and run time meter. The fan is field replaceable.
- 435 mm (D) x 102 mm (W) x 88 mm (H).
- 5 Kg.

### 5.2 Sub-rack

- The Bravo ECI shelf shall be integrated in min 600 mm deep cabinets, Inch/ETSI mounting.
- The Bravo ECI shelf house max four (4) inverter modules and one (1) monitor unit.
- The extension shelf house max four (4) inverter modules and one (1) monitor dummy cover.
- The Bravo ECI shelf is designed with individual DC input, Common AC input and Common AC output.
- Optional rear cover for IP 20 in open rack.
- Max 11 KVA per shelf.
- 480 mm (D) x 19" (W) x 2U (H).
- 6 Kg empty.

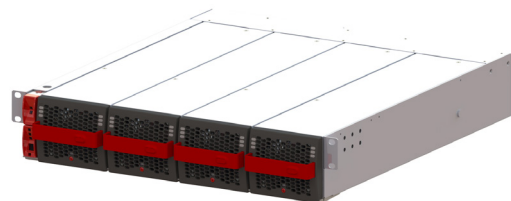

## 5.3 Controller - Inview S

Inview S is an advanced monitoring and controller unit for Bravo 25, Bravo 10, Sierra 25, and Sierra 10 power systems. It allows the user to easily access the system information through inbuilt powerful touch screen graphic display. In addition to the touch screen display, the user can also access the system information through the web interface and SNMP protocol.

The Inview S interface provides the user to access the configuration and setup files of the modules in the system. Also, it is a controller for DC regulation.

Inview S can monitor up to 32 inverters/Inverters and featured with:

- LCD touch screen display
- 2 Digital Inputs
- 2 Output Relay contacts
- Records 5000 events as FIFO



### 5.3.1 Inview S - Connections

Inview S is composed of multiple network ports and inbuilt free potential contacts.

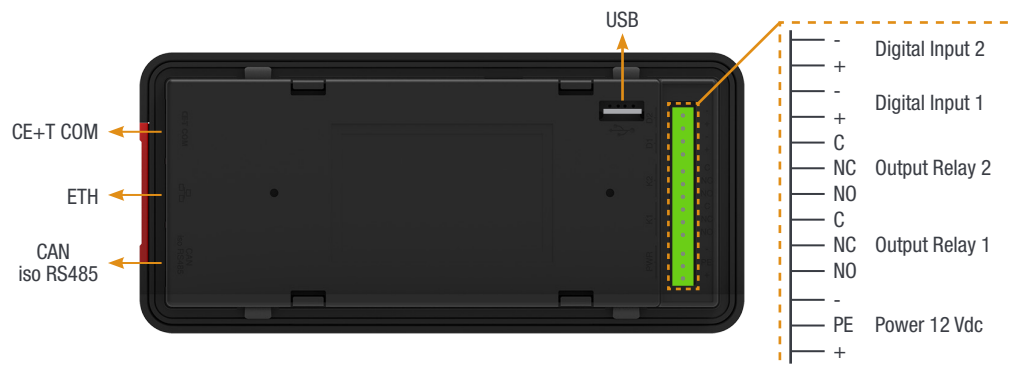

- CE+T COM port is dedicated to establish connection between Inview S and Sierra - shelf.
- ETH port is used for network connectivity and user can access the system information in the web interface.
- CAN / iso RS485 is used share the system (DC) information to MBB (Measure Box Battery).
- USB port is used to access the Inview S configuration and setup files.
- Digital Inputs (D1 and D2): Two potential free Digital Inputs are available for customer connections.
  - Digital Input 1 is assigned for MBP operation if used.
  - Digital Input 2 is assigned for Surge Arrester if used.
- Output Relays (K1 and K2): Two output relays are available and can be used for Major and Minor Alarms
- Power: The unregulated separate +12 V power supply is required for powering Inview S and this power should not be shared with other devices. (CET can provide Auxiliary Power Supply Inverter and the part number is T602004120).

## 6. Accessories

### 6.1 Cabinet

Powder coated (RAL 7024), 19 inch Flat Pack cabinet with 600 x 600 mm foot print. Cabinet designed for top cabling or bottom cabling.

- 1100 mm (600 x 600 mm) 21U
- 1800 mm (600 x 600 mm) 37U
- 2100 mm (600 x 600 mm) 44U

The cabinet comes with a separable top cover to facilitate cabling. Tie strap support at cable entrance/exit.

Door accessory optional.

### 6.2 Manual By-Pass

The manual By-Pass operates via manually operated switches that create a by-pass from mains input to output AC distribution. When in By-Pass, shelves and modules have no AC IN supply, but DC is still present.

To remove the shelf, make sure that the DC feed is off and disconnected.

The manual by-pass is “Make before Break”

NOTE! When the system is in by-pass the load is subjected to mains disturbances.

#### WARNING

**IF AN ATS (Automatic Transfer Switch) IS INSTALLED UPSTREAM, MAKE SURE THAT IT DOES NOT ALLOW TRANSFER BETWEEN AC SOURCES OUT OF SYNC. THE MAXIMUM ALLOWED PHASE SHIFT IS 10°.**

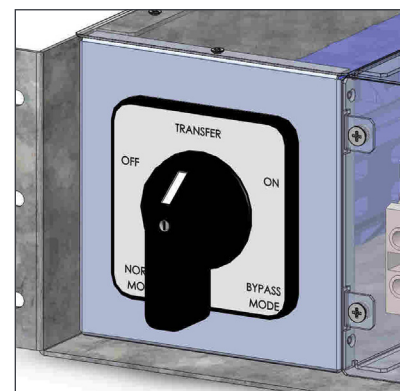

For illustration only

## 6.3 AC Distribution Unit

### 6.3.1 Miniature Circuit Breakers

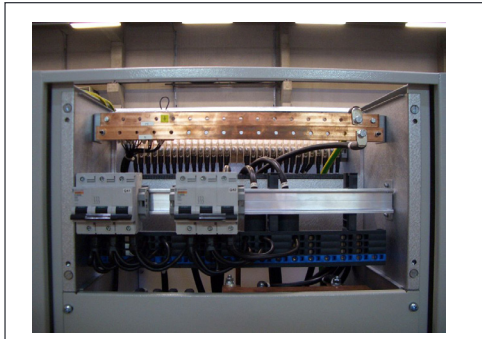

The standard AC output distribution unit is designed with a 35 mm DIN rail, Multi Clip termination board and N/PE copper terminal bars, and built as a part of the cabinet.

The Multi Clip offers unique flexibility during installation and expansion. The terminals are spring loaded and adapt contact pressure to the size of conductor. Only one cable can be inserted per spring loaded terminal.

The AC distribution unit is available with 1 pole, 2 pole or 3 poles.

Max current per AC DU is 200 A, max current per terminal connector is 40 A. Two adjacent terminal connectors shall be used for 63 A breakers.

If an alarm is required for AC output breakers, a help contact attached to each individual breaker is used (OF or SD). The alarm function is common and uses one of the digital inputs on the control unit. The help contact limits the breakers quantity.

	Single pole		Double pole		Three pole	
	w/o help contact	With help contact OF/SD	w/o help contact	With help contact OF/SD	w/o help contact	With help contact OF/SD
Up to 40A	24	16	12	9	8	6

### 6.3.2 MCCB



AC output distribution via MCCB in the range up to 400 A (1p, 2p or 3p).

Max two MCCB per inverter cabinet.



## 7. System Design

### 7.1 A la Carte

The A la Carte is pre-assembled and configured as a single phase or three phase system. The system comprises cabinet, inverter sub rack, inverter modules, manual by-pass, monitor device and AC output distribution.

The A la Carte is available in EPC (Enhanced Power Conversion) or REG (Regular) mode.

The A la Carte (single phase) accommodates 1 to 32 modules, for max 88 kVA.

The A la Carte (three phase) accommodates 3 to 30 modules, for max 82.5 kVA.

By using TUS, the system can parallel up to 2475 kVA

- Dual input (AC and DC) inverter modules (EPC).
- 96% efficiency during normal operation (EPC).
- Always conditioned and filtered output voltage.
- Seamless transfer (0 ms) between primary and secondary source of supply.
- No single point of failure.
- Flexible AC output distribution.
- Full modularity and redundancy.

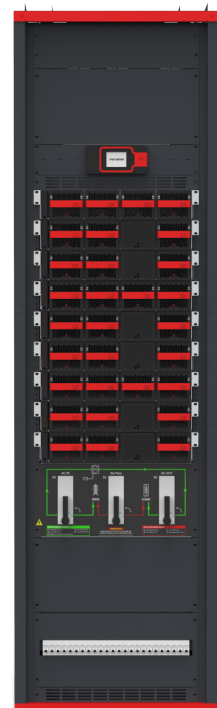

## 8. Installation of Bravo ECI Shelf

- Read safety instructions prior starting any work.
- Do NOT attempt to use lifting eyes to erect the cabinet.
- System is preferable handled without modules.
- Pay attention to the module position, make sure that modules are repositioned in the same slot.
- In three phase systems, the modules are configured as per phase 1 (A, R), phase 2 (B, S) and phase 3 (C, T). As long as the system is not in operation, make sure that modules from one phase are not mixed with modules from another phase.  
(When the system is running, modules can be moved from one phase to another without issue.)

### 8.1 Mounting kit for Bravo ECI shelf

The fixing brackets, together with the sliders, allow for different cabinet depths.

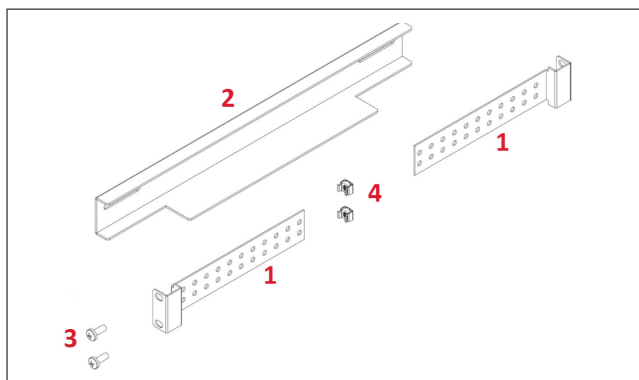

- 1** → Fixing brackets - 4 Nos
- 2** → Slider - 2 Nos
- 3** → Mounting screws - 12 Nos
- 4** → Cage nuts - 12 Nos

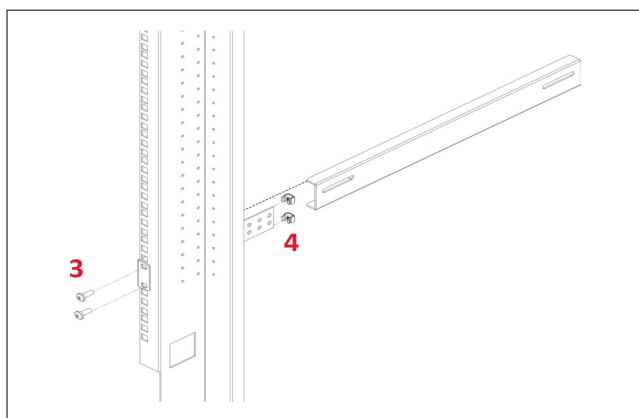

Assemble the sliders and adjust the length to suit the mounting depth.

Fix cage nuts (**4**) in the cabinet front and rear frame of the left and the right side.

Fix the left and right slider of the cabinet with the supplied screws (**3**).

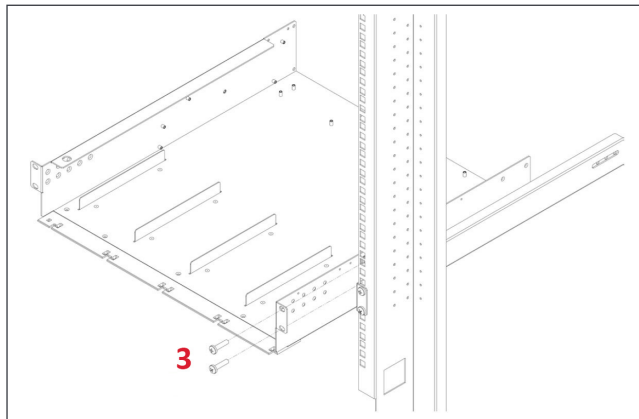

Fix cage nuts (4) in the mounting frame.

Slide the shelf in position and fix the shelf with the supplied screws (3).

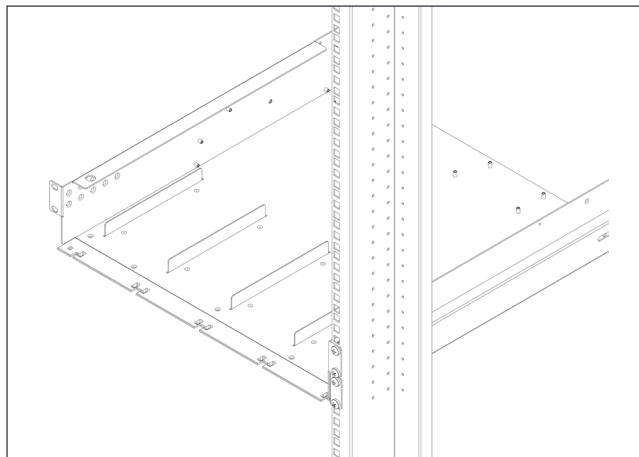

Finished.

## 8.2 Electrical installation for Bravo Shelf

### 8.2.1 Pre requisites

- The sub-rack have markings for all terminations.
- All cables shall be rated at Min 90 deg C.
- Electrical terminations shall be tightened with 5Nm.
- All connection screws are M5 x 12 mm.
- DC Input-Individual (per module), observe polarity.
- AC Input / AC output-Common (per shelf), respect phases.
- Wire all positions in the sub-rack for future expansion.
- Input AC / Output AC / Input DC / Signal cables shall be separated.
- Cable crossings shall be done in 90 deg angles.

### 8.2.2 Terminations

All terminations are clearly marked.

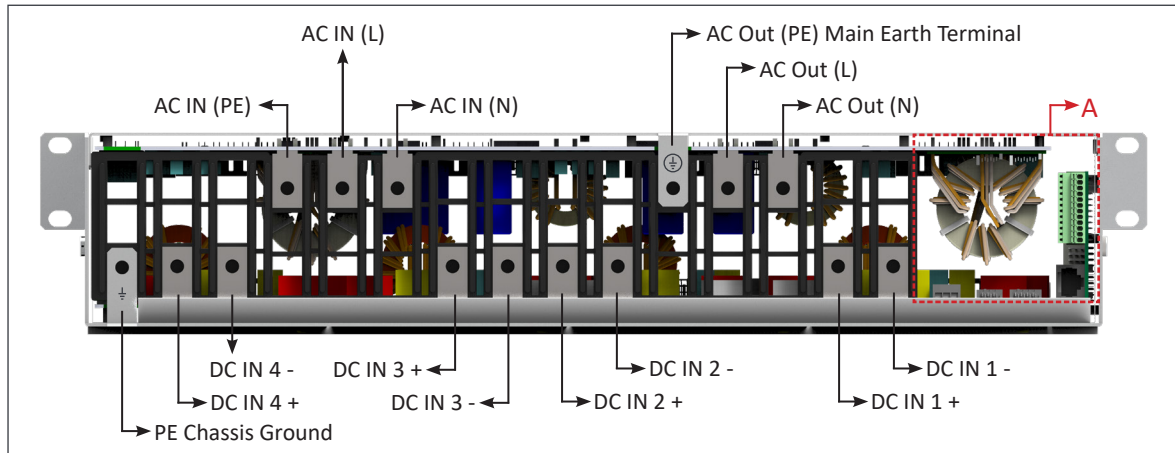

Bravo 25 - 48/120 - Shelf Rear Details

### 8.2.3 Grounding

“PE CHASSIS GROUND” 

PE Chassis ground shall be wired to MET or distributed earth bar connected to MET, according to local regulations.

### 8.2.4 DC Input

Model	MCB per inverter module	Cable, min	Connector	Torque
Sierra 25 - 48/120	80 A	2 x 16 mm <sup>2</sup>	M5	5 Nm

### 8.2.5 AC Input

**WARNING !!!**  
Recommendation of IEC 60364 4. 43

#### 431.3 Disconnection and reconnection of the neutral conductor in multi-phase systems

Where disconnection of the neutral conductor is required, disconnection and reconnection shall be such that the neutral conductor shall not be disconnected before the line conductors and shall be reconnected at the same time as or before the line conductors.

	Cable, min	Connector	Torque
Sierra 25 - 48/120	4 x 10 mm <sup>2</sup>	M5	5 Nm

Note: Icc value measured as 140 A<sub>rms</sub> per shelf with four modules.

### 8.2.6 AC Output

	MCB per shelf	Cable, min	Connector	Torque
Sierra 25 - 48/120	2P 80 A	4 x 10 mm <sup>2</sup>	M5	5 Nm

### 8.2.7 Signalling

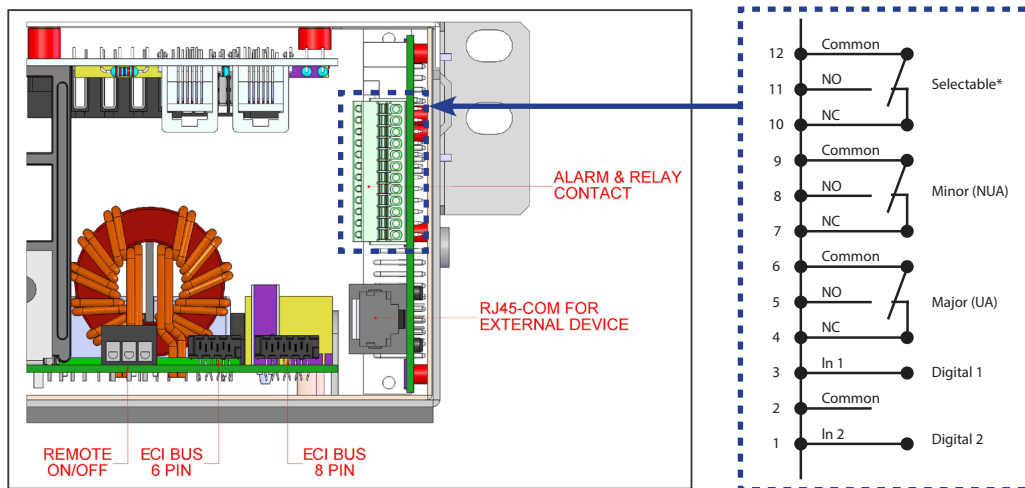

#### Relay characteristics (Selectable, Major, Minor)

- Switching power 60 W
- Rating 2 A at 30 Vdc / 1 A at 60 Vdc
- Max wire size 1 mm<sup>2</sup>

#### Digital input characteristics (Digital In 1 / 2)

- Signal voltage +5 Vdc (galvanic insulated)
- Max wire size 1 mm<sup>2</sup>

### 8.2.8 Remote ON/OFF

Notice: The shelf is by default equipped with a connection between pin 3 and 2. If remote ON/OFF is not used the strap shall remain in all connected shelves. Should the remote ON/OFF be used, all straps must be removed and in one (1) shelf replaced with a changeover contact or emergency button.

- The remote ON/OFF switch the output AC OFF.
- Input AC and input DC is not affected by the remote ON/OFF.
- The remote ON/OFF can be connected to any shelf.
- The remote ON/OFF requires changeover contacts, one input opens as the other close. If both transitions are not picked up the status is not changed.

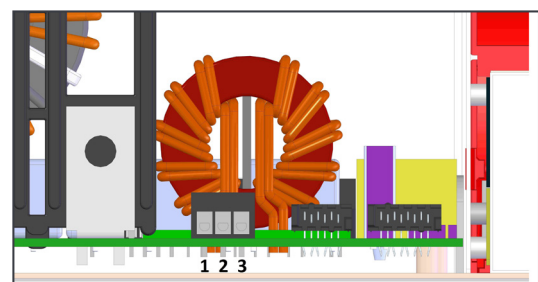

### Relay characteristics (Remote ON/OFF)

- Signal voltage +5 VDC (galvanic insulated)
- Max wire size 1 mm<sup>2</sup>

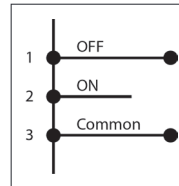

### Functional table for remote ON/OFF function

#	Pin 1-3	Pin 2-3	Status	Indication
1	Open	Open	Normal operation	All (Green)
2	Closed	Open	OFF	AC output (OFF) AC Input (Green) DC Input (Green)
3	Open	Closed	Normal operation	All (Green)
4	Closed	Closed	Normal operation	All (Green)

### Warning:

If remote ON/OFF is not used, pin 2 and 3 MUST be bridged together!

### 8.2.9 Internal bus (ECI Bus 6 pin / ECI Bus 8 pin)

- In A la Carte systems the internal Bus is pre installed.
- The internal bus comprise of a 6 pole ribbon cable and an 8 pole ribbon cable.
- The internal bus connectors are sensitive and special caution should be taken during installation to keep them out of harms way.
- The internal bus is connected from the first shelf to the last shelf.

### 8.2.10 Rear cover

- The rear cover provides IP 20 protection for the rear terminations when required.
- The rear cover is snapped into position in the rear of the sub-rack.
- Remove material using a pair of side-cutters to allow cable entry and exit.
- The rear cover is ordered separately.

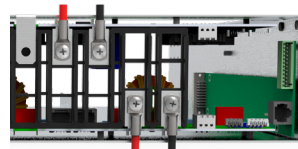

Connect the cables.

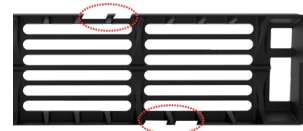

Cut appropriate size on the protection cover for cable access.



Fix the protection cover at rear side of the shelf.

## 9. Installation of Cabinet (A la Carte)

### 9.1 Unpacking the system

CE+T cabinets are always fixed on a pallet, and then packed in a wooden crate.

These crates are usually delivered laying flat, horizontally.

To unpack your cabinet, we recommend the following method:

1. Make sure that the crate is laying flat, with the correct side up. This side is identified by a double red arrow.
2. Remove the top cover in order to be able to identify the top and bottom sides of the cabinet.
3. Raise the crate vertically with the top side of the cabinet up. Make sure that the cabinet does not fall forward out of the crate while you do so.
4. Remove the cabinet and its attached pallet from the crate.

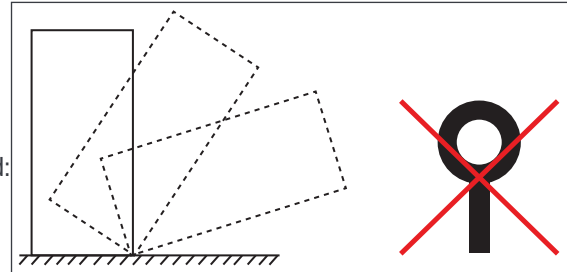

If you prefer to take the wooden crate apart before raising the cabinet, make sure you do not damage or dent the cabinet while doing so.

**Warning :** The top cover fixing bolts may NEVER be replaced with lifting eye bolts.

### 9.2 Module packing

When modules are ordered **together with a system**, they are either delivered in the cabinet or on a separate pallet.

- If you find the modules in the cabinet : you may want to remove them in order to raise the cabinet more easily, **but before you do so make sure to have identified in which slot was each module. Indeed, it is important to replace each module in the same slot** it was delivered in!
- If the modules have been delivered separately, in carton on pallet, they will be clearly identified in order to be placed in the right slot.
- It is important to place the modules in the right slot, as this will ensure that the addressing of each module in the config file corresponds to the physical slot. Without this, the system will of course function properly but you might find it difficult to identify on which modules your applying changes you would be bringing to the config file.
- Also, in 3 phase systems, replacing modules configured to function in a specific phase in a slot assigned to another phase will result in the module to be un-synchronized. Your system may not start and you will have to reconfigure manually each module that was misplaced.

If you ordered modules only:

- If they are meant to be used in running systems or in a not operational single phase system, you may insert them in any slot.
- If they are meant to be placed in a not yet started 3 Phase system, follow these steps:
  - Insert one module per phase.
  - Start the system according to the start-up and commissioning procedure.
  - Insert the remaining modules progressively.

Module packing material shall be taken apart.

### 9.3 Removing the cabinet rear protection

Wooden wedges are fixed at the back of the cabinet to prevent parts from moving and sustaining damage during transportation. These wooden wedges must be removed before going further with the cabinet's installation and commissioning

1. Remove the rear panel.
2. Identify the protection (see the following figure).
3. Cut the tie wraps holding the back wedges and remove them.

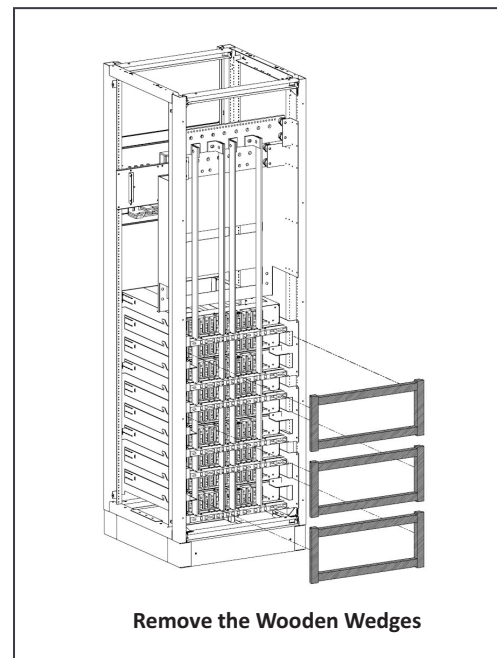
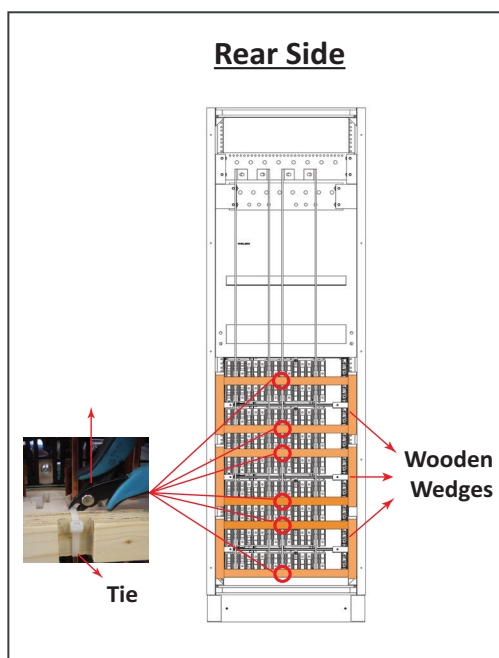

### 9.4 Electrical installation

- All cables shall be halogen free and rated min 90 deg C.
- Wire all positions for future expansion.
- Input AC / Output AC / Input DC / Signal cables shall be separated.
- Cable crossings shall be made at 90 deg angles.
- Empty module positions shall be covered with blank or dummy module.



### 9.4.1 Positioning

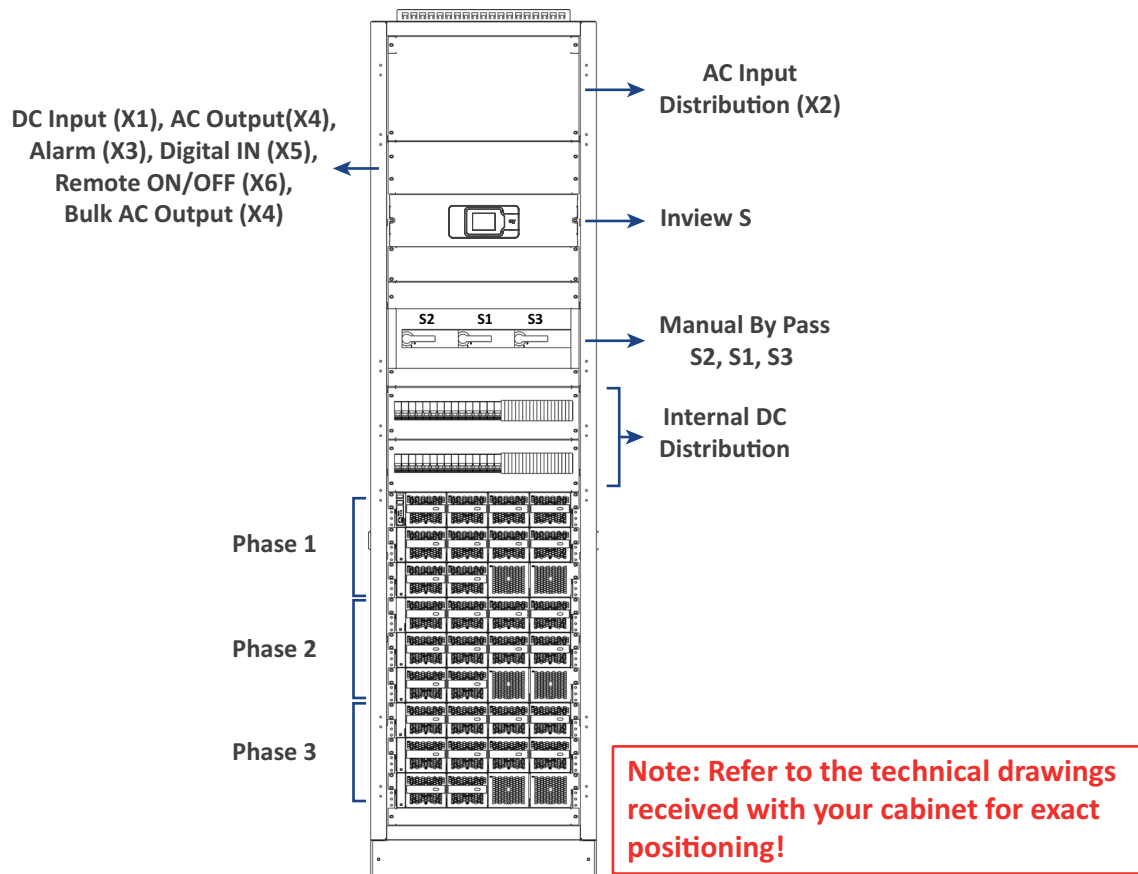

### 9.4.2 Cabling

Note: Do not block the airflow through the top of the cabinet. Cables are run through the top or bottom of the cabinet. The top cover can be split into two parts to facilitate cabling. The top cover accommodates nylon tie straps used to strap the cables.

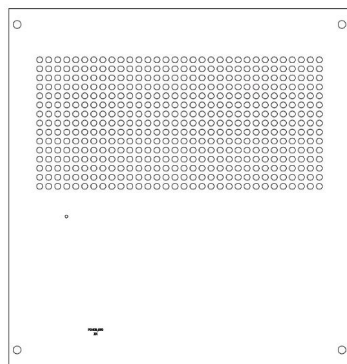

Top Plate - Type I

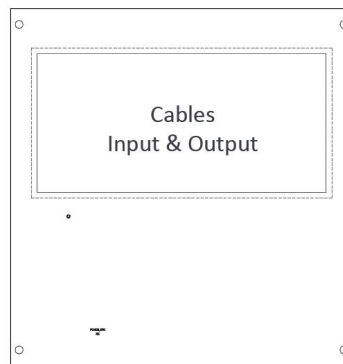

Top Plate - Type II

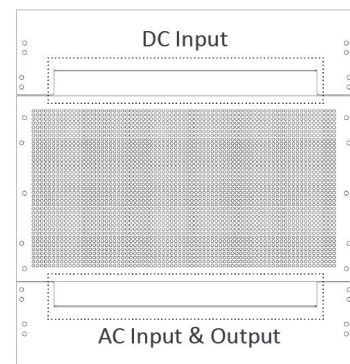

Top Plate - Type III

### 9.4.3 Grounding

Ground terminals are located in the top rear left corner, labelled “PE CHASSIS GROUND”

PE Chassis ground shall be wired to MET or distributed earth bar (MET). Ground must be terminated even if commercial mains is not available.

According to local regulations, Min 16 mm<sup>2</sup>.



### 9.4.4 Surge Suppression

The mains (AC) supply of the modular inverter system shall be fitted with suitable Lightning surge suppression and Transient voltage surge suppression for the application at hand. Manufacturer’s recommendations of installation shall be adhered. It is advisory to select device with alarm relay for function failure.

Indoor sites are considered to have a working lightning surge suppression device in service.

- Indoor sites           Min Class II.
- Outdoor sites :       Min Class I + Class II or combined Class I+II.

### 9.4.5 AC Input (X2)

**WARNING !!!**  
Recommendation of IEC 60364 4. 43

#### 431.3 Disconnection and reconnection of the neutral conductor in multi-phase systems

Where disconnection of the neutral conductor is required, disconnection and reconnection shall be such that the neutral conductor shall not be disconnected before the line conductors and shall be reconnected at the same time as or before the line conductors.

**WARNING !!!**

#### Input Neutral is required to operate the Inverter, UPS

In TN-S System no 4 pole input switch or circuit breaker shall be used. If you have to use 4 pole protective device, be aware that the neutral against the ground is floating. The inverter, UPS will operate without problem but you may infringe the local regulation.

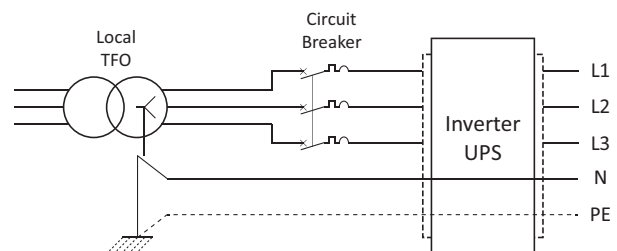

The AC input is wired to a screw terminal.

Max cable area is 180 mm<sup>2</sup>

### 9.4.5.1 Single phase

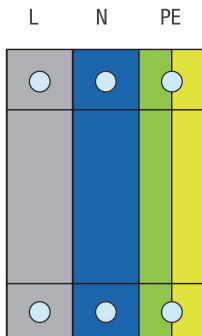

### 9.4.5.2 Three phase

**NOTE:** The three phase input is 123, ABC, RST phase sensitive; clockwise rotation is recommended. Phase one starts at 0° phase shift, while the other phases will be at -120° phase shift and + 120° phase shift resulting in three phase output.

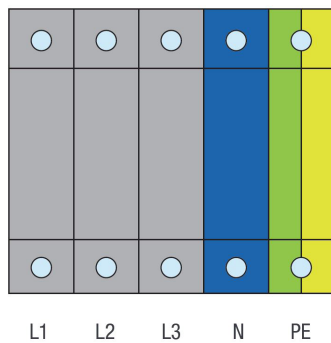

## 9.4.6 DC Input (X1)

### 9.4.6.1 Bulk Input

- Common DC input per system.
- **Note:** Screws and nuts are not included in the delivery.
- M12 holes.
- Internal DC distribution with circuit breakers (Q01-Q32) per inverter module.
- Max 8 x 240 mm<sup>2</sup> per pole (group).

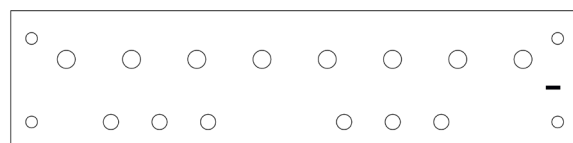
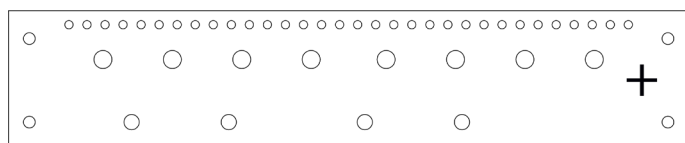

### 9.4.6.2 2 DC Input

- 2 x Common DC input per system.
- **Note:** Screws and nuts are not included in the delivery.
- M12 holes.
- Internal DC distribution with circuit breakers (Q01-Q32) per inverter module.
- Max 3 x 240 mm<sup>2</sup> per pole (group).

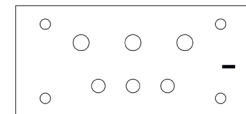
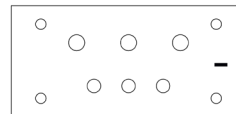
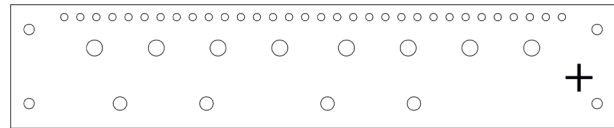

### 9.4.6.3 3 DC Input

- 3x Common DC input per system.
- **Note:** Screws and nuts are not included in the delivery.
- M12 holes.
- Internal DC distribution with circuit breakers (Q01-Q32) per inverter module.
- Max 2 x 240 mm<sup>2</sup> per pole (group).

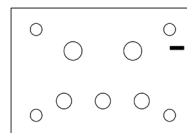
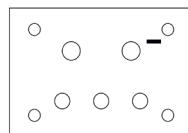
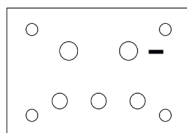
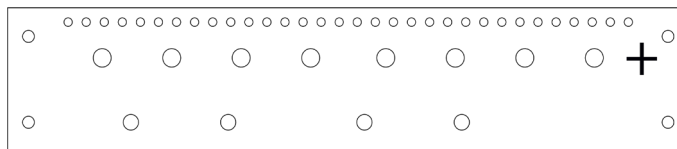

### 9.4.6.4 Individual Input

- Individual DC input per module/shelf and common return.
- **Note:** Screws and nuts are not included in the delivery.
- M6 holes for positive bus bar per connection.
- Max 35 mm<sup>2</sup> per connection terminal.

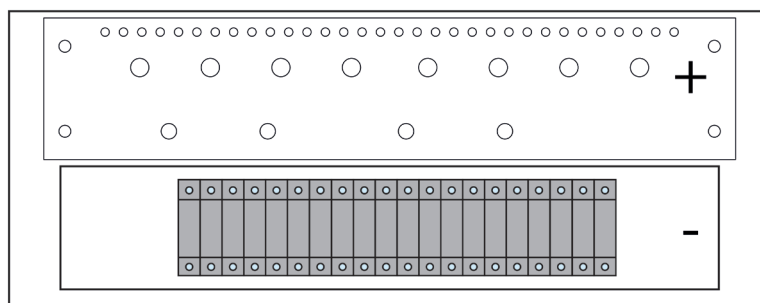

### 9.4.7 Connection Table – AC Input (X2) & Output (X4) for 48 Vdc version

The AC input supply breaker shall be 2p for single phase, and minimum 3p for three phase.

Power (kVA)		AC Input & Output Screw terminal		
1ph	3ph	Calculated	Fuse/CB	Min.Cable mm <sup>2</sup>
12	-	52.5 A	63 A	16
24		105 A	125 A	35
36		157 A	160 A	70
	36	3 x 52.5 A	3 x 63 A	3 x 16
48	-	210 A	250 A	95
60		262.5 A	300 A	150
72		315 A	350 A	180
	72	3 x 105 A	3 x 125 A	3 x 35
84	-	370 A	400 A	180
	90	3 x 131 A	3 x 160 A	3 x 70
96	-	420 A	630 A	2 x 180

### 9.4.8 Connection Table DC Input 48 VDC (X1)

Power (kVA)		DC Input Bulk		DC Input 2 Common		DC Input 3 Common		DC Input individual (1 Feed per Module)	
1ph	3ph	Fuse/CB	Min Cable mm <sup>2</sup>	Fuse/CB	Min Cable mm <sup>2</sup>	Fuse/CB	Min Cable mm <sup>2</sup>	Fuse/CB	Min Cable mm <sup>2</sup>
12	-	250 A	120	-	-	-	-	63 A	Live: Screw terminal 10 mm <sup>2</sup> Common: Cable lug. M5-5 Nm torque
24		500 A	240	250 A	120	-	-		
36		800 A	2 x 240	-	-	250 A	120		
	36			400 A	240				
48	-	1000 A	4 x 150	630 A	2 x 150	-	-		
60		1250 A	3 x 240	-	-	-	-		
72		2 X 800 A	4 x 240	800 A	2 x 240	630 A	2 x 150		
	72			-	-				
84	-	2 X 1000 A	8 x 150	-	-	-	-		
	90	2 X 1000 A	8 x 150	-	-	800 A	2 x 240		
96	-	2 X 1000 A	8 x 150	1000 A	4 x 150	-	-		

### 9.4.9 Signalling

The illustration below shows the X3 relays contacts in a non-alarm state when the system is operational. In this case, the relays are energized and as below.

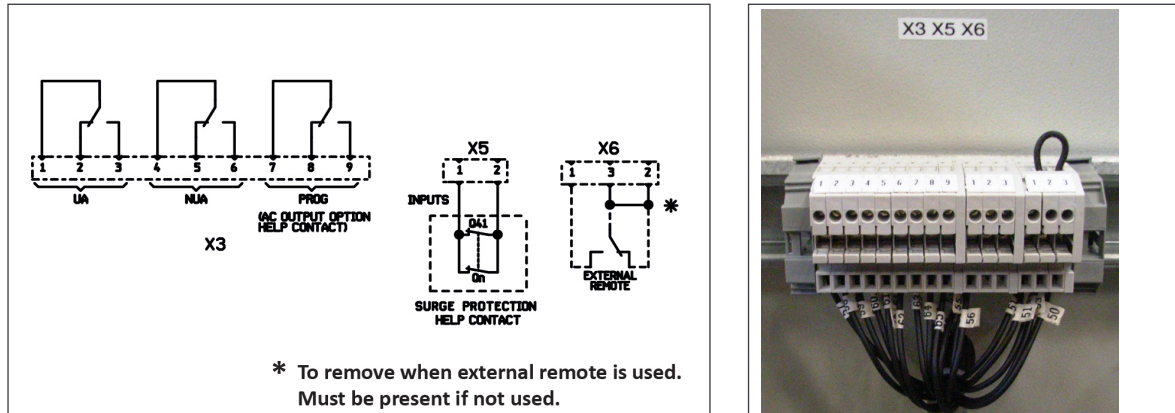

When an alarm occurs, the X3 relay contacts are de-energized and switch.

#### 9.4.9.1 Alarm (X3)

Relay characteristics X3 (Major (UA), Minor (NUA), Prog)

- Switching power 60 W
- Rating 2 A at 30 VDC / 1 A at 60 VDC
- Max wire size 1 mm<sup>2</sup>

#### 9.4.9.2 Digital In (X5)

Input characteristics X5 (Digital In 1, Digital In 2)

- Signal voltage +5 VDC (galvanically insulated)
- Max wire size 1 mm<sup>2</sup>

#### 9.4.9.3 Remote ON/OFF (X6)

**Note:** The system is by default equipped with a connection between pins 3 and 2. If remote ON/OFF is not used the strap shall remain. Should the remote ON/OFF be used the strap must be replaced with a changeover contact or emergency button.

- The remote ON/OFF switches the output AC OFF.
- Input AC and input DC is not affected by the remote ON/OFF.
- The remote ON/OFF can be connected to any shelf.
- The remote ON/OFF requires changeover contacts, one input opens as the other closes. The status is not changed unless both transactions are detected.

- Digital input characteristics (Remote ON/OFF)
  - Signal voltage +5 VDC (galvanically insulated)
  - Max wire size 1 mm<sup>2</sup>

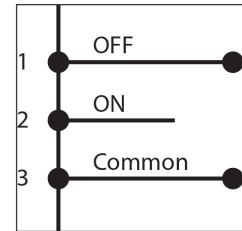

Functional table for remote ON/OFF function

#	Pin 1-3	Pin 2-3	Status	Indication
1	Open	Open	Normal operation	All (Green)
2	Closed	Open	OFF	AC output (OFF) AC Input (Green) DC Input (Green)
3	Open	Closed	Normal operation	All (Green)
4	Closed	Closed	Normal operation	All (Green)

**Warning:**

If remote ON/OFF not used, pin 2 and 3 **MUST** be bridged together!

# 10. Interface

## 10.1 Inverter module

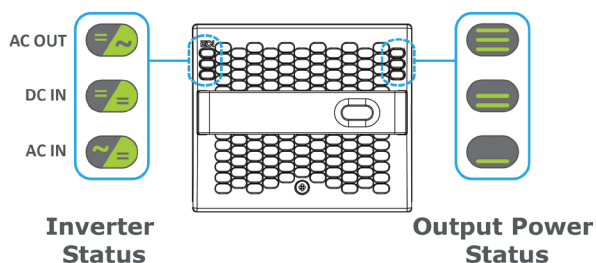

Inverter Status LED	Description	Remedial action
OFF	No input power or forced stop	Check environment
Permanent green	Operation	
Blinking green	Inverter OK but working conditions are not fulfilled to operate properly	
Blinking green/orange alternatively	Recovery mode after boost (10 In short circuit condition)	
Permanent orange	Starting mode	
Blinking orange	Modules cannot start	Check Inview
Blinking red	Recoverable fault	
Permanent red	Non recoverable fault	Send module back for repair

Output Power (redundancy not counted)						
<5%	5% to 40%	40 to 70%	80 to 95%	100%	100% = overload	Output Power (redundancy not counted)
×	×	×	≡	≡	≡	Status output power LED
×	×	≡	≡	≡	≡	
—	—	—	×	—	—	
1B	1P	2P	2P	3P	3B	Behaviour (B = blinking – P permanent )





## 10.2 Inview S - LCD interface

Inview S LCD interface is a 2.8-inch touch screen. It does not have any user account, the user can only view the system details. The LCD interface is protected with the PIN during any action request.

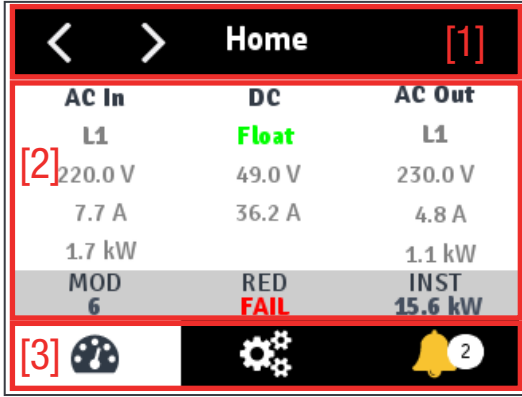
Once system is powered upon, the Inview S is up and ready for operation.



Home [1]		
AC In	DC	AC Out
L1	Float	L1
[2] 220.0 V	49.0 V	230.0 V
7.7 A	36.2 A	4.8 A
1.7 kW		1.1 kW
MOD 6	RED FAIL	INST 15.6 kW
[3] 		 2

- **[1] Header**

Displays the title of the current page and navigation buttons for next and previous page. In some pages, Up and Down navigation buttons appear at the right side, indicating more contents are present.

- **[2] Information Area**

Provides information about the corresponding page.

- **[3] Toolbar**

The toolbar is present at the bottom throughout the interface, to provide quick access to following pages:

- Measures
- Settings
- Alarms and Logs

### 10.2.1 LED indications

Three LED's are present at front side of the controller to indicate major alarm, minor alarm, and system status.

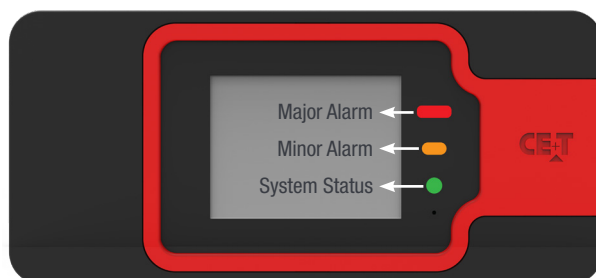

## 10.2.2 Menu structure

The below tree provides an overview of the menu structure in the Inview S LCD interface.

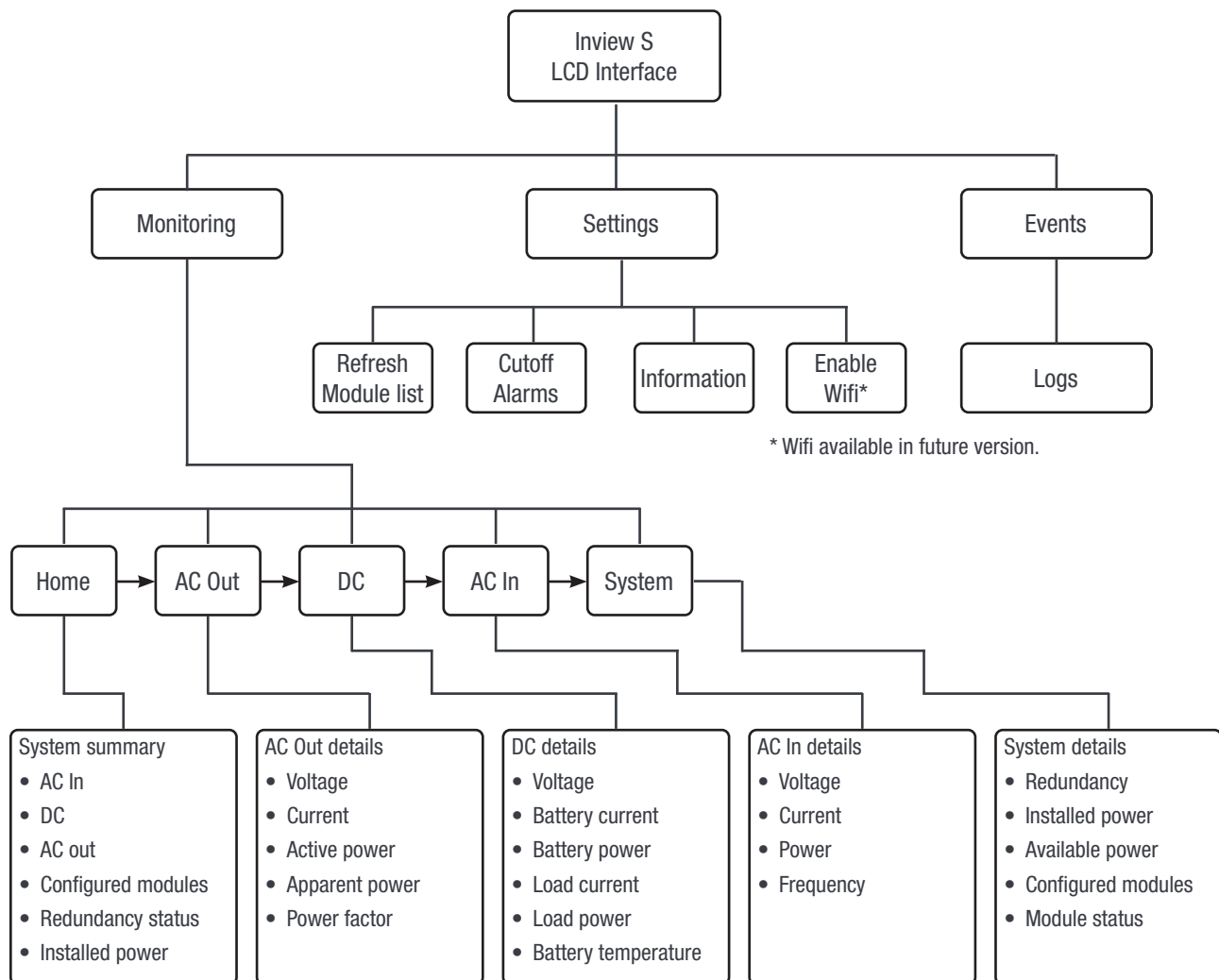

## 10.3 Inview S and Inview S Slot - Web Interface

The web interface of both controller Inview S and Inview S Slot is same, and the user can access the controller on the laptop through ETH port.

This section provides an overview of the web interface, refer Inview S user manual for detailed information.

### 10.3.1 Login

Open the web browser and type the IP address **10.250.250.1** in the address field and press enter.

**Note:** Use any one of the following latest version of web browser: Google Chrome, Mozilla Firefox, Safari or Internet Explorer.

Inview S has three login – Basic, Expert and Admin. All three login is password protected.

The default password for all three logins is “1234”.

Basic login can only browse the pages and download the files, but Expert and Admin login can access and also modify the system parameter values.

An auto-logout feature is available to avoid a user being connected all the time and blocking the system. When no action is performed for more than **10 minutes**, the session will expire and goes to login screen.

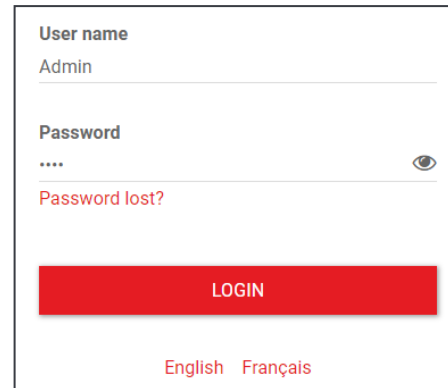

### 10.3.2 Interface Areas



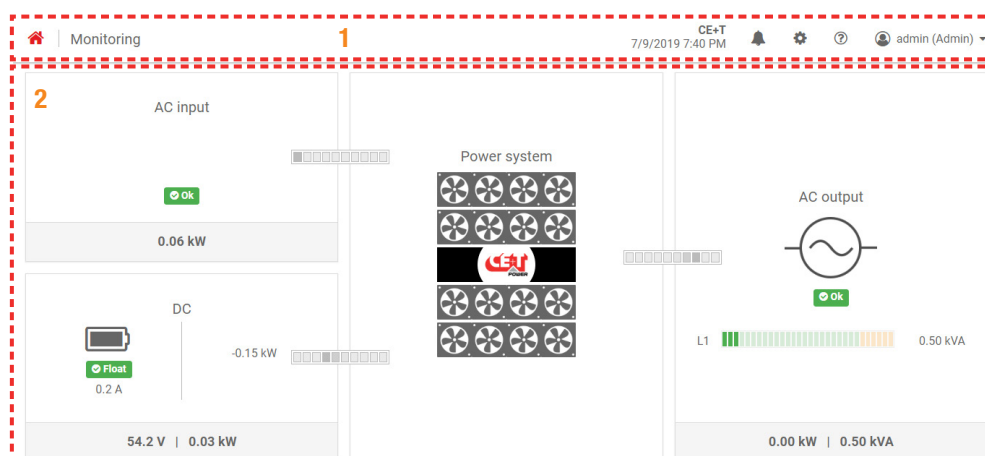

- 1 → Header
- 2 → Main Page



### 10.3.2.1 Header



The tabs in header provide quick access to the corresponding pages.

- 1 → **Home:** Tapping on  goes to the home page from any page you are accessing in the interface.
- 2 → **Breadcrumbs:** Provide navigation of the page. It trails all levels so that user can know where you are within the interface and can go to any previous menu.
- 3 → **Date and Time:** Display the date, time and the location of the system.
- 4 → **Events:** Tapping on  goes to Events and Logs page.
- 5 → **Settings:** Tapping on  provide access to Users, Parameters and Maintenance pages.
- 6 → **Info:** Tapping on  in the home page, provides brief information about the parameters, while in other pages provide the latest three ongoing events.
- 7 → **Account:** Provides the information of which account is logged in (Basic, Expert or Admin). Clicking on drop-down arrow user can access the following pages:
  - **Administration** - Provide quick access to Users, Parameters and Maintenance pages. (Administration page will appear only in Expert login).
  - **About** - Provides the information of Inview product details and network connectivity details.
  - **Logout** - An act of logging out of an Inview S.

### 10.3.2.2 Home Page

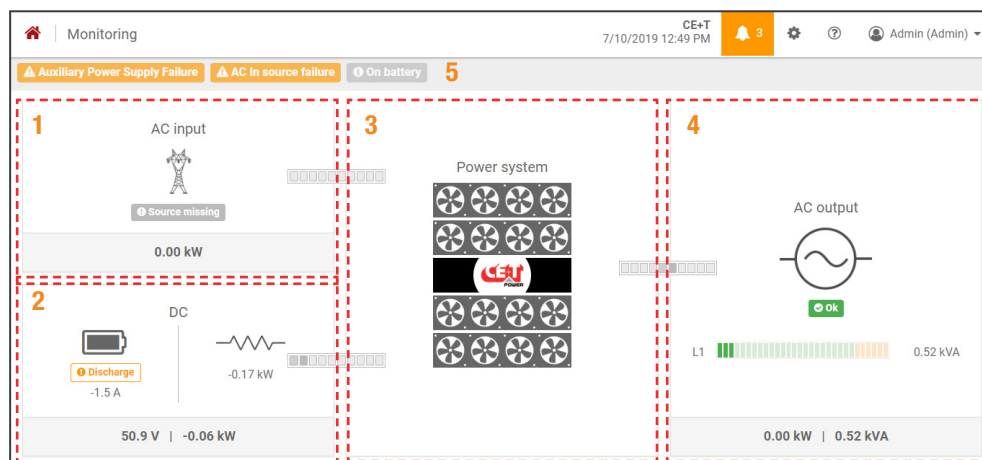

- 1 → **AC Input:** Tapping on the AC Input region displays the page contain all measurements regarding AC Input.
- 2 → **DC:** Tapping on the DC region displays the page contain all measurements regarding Battery and DC Output.
- 3 → **Power System:** Tapping on the Power System region display the page contain regarding system information such as overall system power and also in each phase, configured modules, active modules, and list of detected modules and accessories.

- 4 → **AC Output:** Tapping on the AC Output region displays the page contain all measurements regarding AC Output. Regardless of the system configuration (1P, 3P), display the power fed to the load on each phase.
- 5 → **Notifications:** Display the current generated alarms and events.

**Note:** To know more about Inview S and Inview S Slot operation, refer to the Inview manual and it is available on request.

# 11. Inserting/removing/replacing - modules

## 11.1 ECI Inverter

- The ECI inverter is hot swappable.
- When a new module is inserted in a live system it automatically adapts to a working set of parameters.
- When a new module is inserted in a live system it automatically assigns the next available address.

### 11.1.1 Removal

**Notice:** When one or several inverter modules is/are removed access to live parts becomes possible. Replace module(s) with dummy cover without delay.

1. Rotate the screw in anti clockwise by using cross head screw driver to unlock the latch.
2. Hold the front handle and pull the module out.
3. Replace with a new module or a blind unit

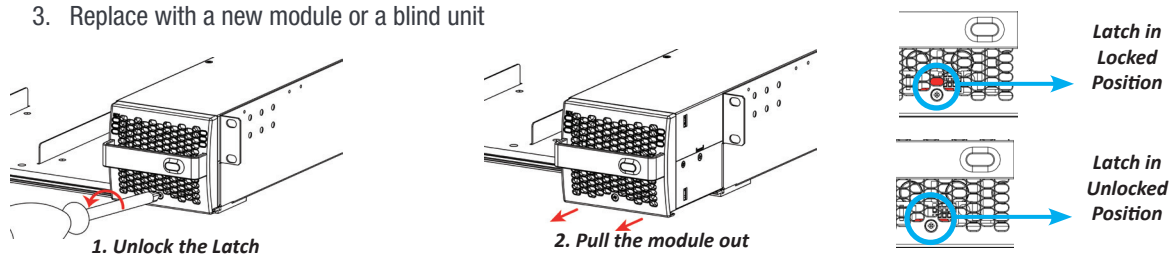

### 11.1.2 Inserting

1. Check module compatibility (DC Voltage!).
2. Place the module in the shelf and slide in.
3. Using the module handle, push firmly until the unit is properly connected.
4. Rotate the screw in clockwise by using cross head screw driver to lock the latch.
5. The module will start up and take the first address available on the bus.

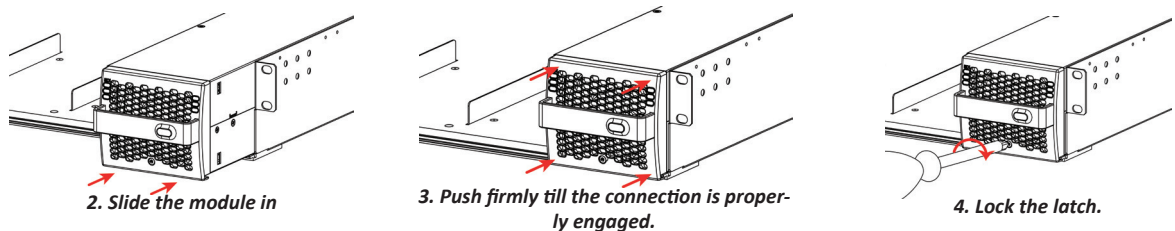

## 11.2 Inview S

### 11.2.1 Panel Mounting

Before mounting the Inview S in the system, route all the required connection cables from the system and place near to the Inview S mounting location.

1. Place the Inview S in the panel sheet.
2. Lock all the four latches at the rear side of the Inview S in the panel sheet.
3. Connect required connection cables to the Inview S.
4. Place the panel sheet in the system and fix it with screws.

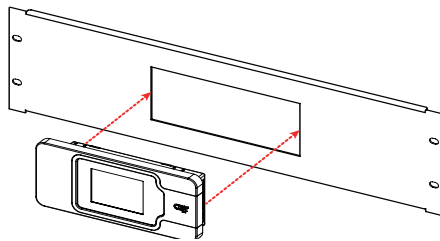

*Place the Inview S in the panel sheet*

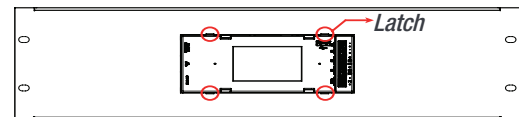

*Fix it with four latches*

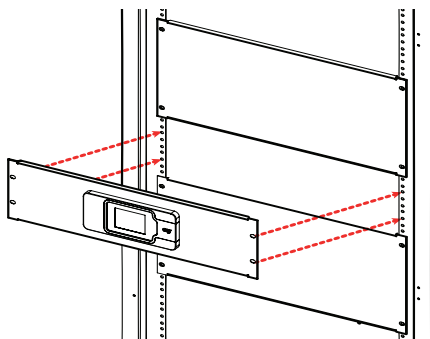

*Connect wires and place the panel sheet in the cabinet*

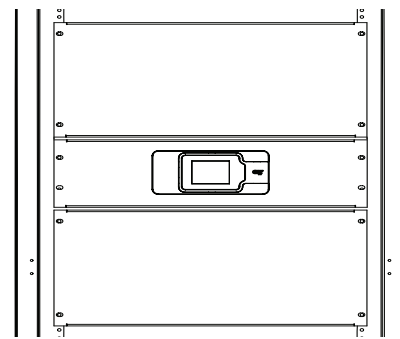

*Fix the panel sheet with screws*

### 11.3 Fan replacement

The FAN life is approximately 60,000 (Sixty Thousand) hours. The inverter modules have fan runtime meters and fan failure alarms. Fan failure can result from a failing fan or driver circuit.



1. Let the module rest at least 5 minutes before initiating work.
2. The inverter front cover must be removed. Use a screw driver and remove the screws on both side of the module.
3. Free up the fan. (Note the fan connector and wires position).
4. Disconnect the supply cord, and remove the fan..
5. Replace with new fan and connect supply cord.
6. Place the front cover and tighten the screws on both sides of the module.
7. Check fan for operation.
8. Access Inview through web interface and reset the fan run time alarm.

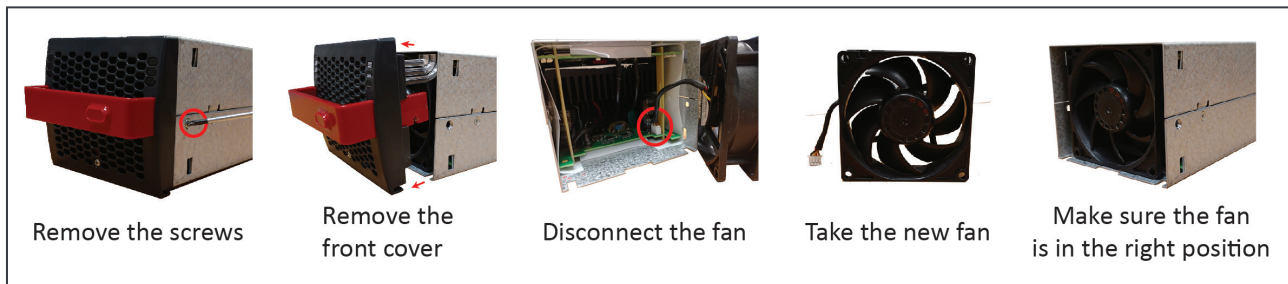



## 12. AC Output Distribution

### 12.1 Miniature Circuit breaker Installation/Removal

Circuit breakers are normally factory installed.

How to add breakers:

1. Insert the short connection cable (10 mm<sup>2</sup> (included)) in the breaker Line-side and tighten.
  - Up to 40 A breaker - use one connection cable.
  - 63 A breaker - use two connection cables.
2. Clip breaker on to the DIN rail.
3. Insert insulated screw driver into the terminal to load the spring.
4. Insert connection cable and remove screw driver.
5. Connect load cable to breaker, Neutral and Ground.
6. Switch breaker ON.

Remove breaker in reverse order

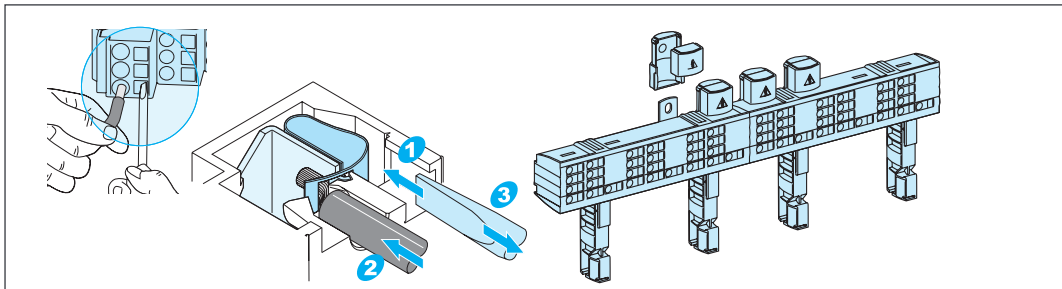

### 12.2 MCCB

MCCBs are factory installed.

A wide range of breakers is used. Delivered breakers may vary from the example shown in the picture.

1. Make sure that the breaker is in OFF position.
2. Connect load cables to the terminal.
3. Switch the breaker ON.



## 13. Manual By-Pass (MBP)

Manual By-Pass has to be operated by trained people only.

When system is in manual by-pass the load is subjected to mains voltage without active filtering. Output alarm is activated when system is in manual by-pass.

The Manual By-Pass cannot be operated remotely.

The Manual By-Pass can be integrated into the CE+T cabinet if requested at time of order. A Manual By-Pass purchased separately must comply with the instructions within section 13.2, page 42.

### 13.1 Pre-requisites

Commercial AC power must be present, and the Inverter must be synchronized with it, before operating MBP. The upstream commercial breaker must be correctly sized to accept the overload, and if the AC is supplied by a Gen-set, the minimal required power will be twice the nominal power of the Inverter.

The Inverter may be overloaded during the MBP procedure, depending on voltage network and output. Inverter voltage setting: To reduce the impact of an overload, the Inverter power and current will be reduced from 150% to nominal value.

The by-pass switch disconnects all AC voltage on the shelves but has no effect on the DC feeding the Inverter and the remote alarm terminal.

**It is requested in order to reduce the inrush current during manual by pass operation to adjust the Inverter AC output voltage to the same value as AC input voltage. If the difference between AC input and AC output voltage exceed 5 Vac, there is a risk of shutdown of Inverter due to high inrush current during the return to normal operation from Manual By Pass engaged.**

### 13.2 MBP Auxiliary connection

If manual by pass is installed in the system and its auxiliary should be wired as per the following:

- MBP - Single rotary switch

**Note: The below connection is for a sub-rack system, and auxiliary (Aux) number varies depending upon the MBP switch. So it is recommended to refer the technical sheet received along with the system.**

- Connect Aux3 of MBP to Digital Input 01 of controller. So that the controller gets information when MBP is engaged.
- Connect Aux1 and Aux2 of MBP to Remote ON/OFF terminal in the shelf where controller is installed.

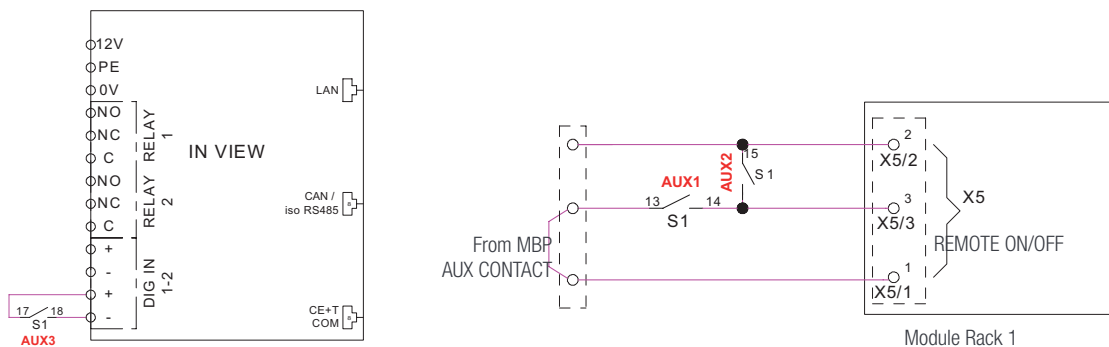

- MBP - Three independent switch

- Connect auxiliary wire from MBP switch (S1) to Digital Input 01 of controller. So that the controller gets information when MBP is engaged.
- Connect auxiliary wire from MBP switch (S1) and AC input switch (S3) to Remote ON/OFF terminal in the shelf where controller is installed.

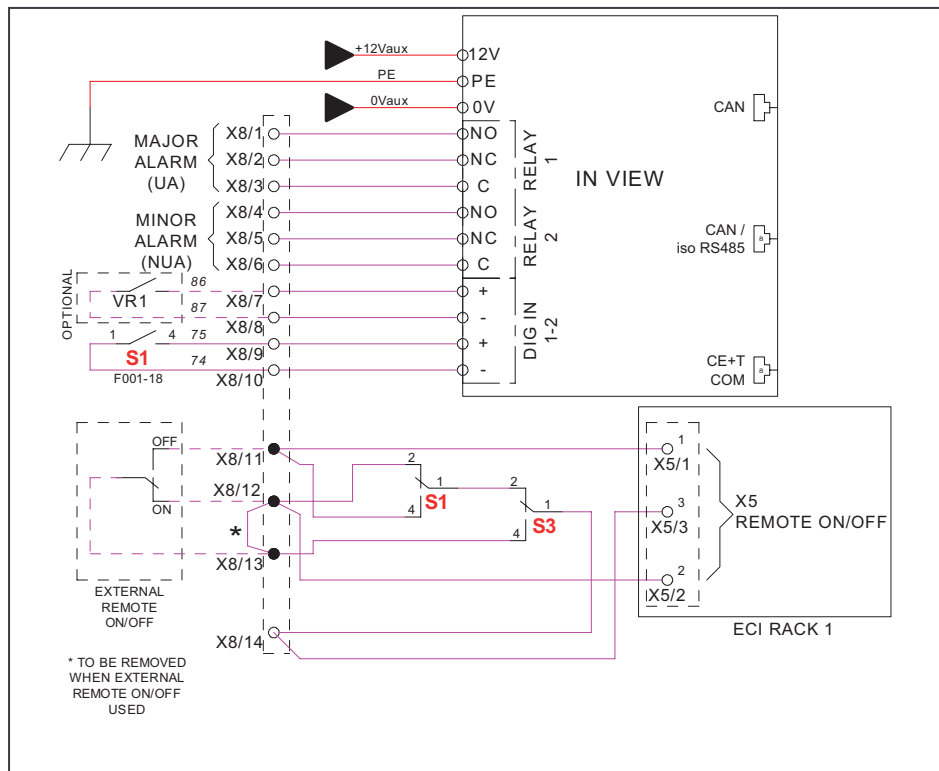

### 13.3 Manual Bypass operation

Manual Bypass operation creates a bypass from mains input via output AC distribution. Inverter modules are bypassed and possible to disconnect without impacting the load.

Manual By-Pass operation is “Make before Break” logic

The sierra system has a single rotary switch or three individual switches depending upon the system configuration, and the operation also varies for each model.

#### 13.3.1 MBP - Single rotary switch

In this model, manual bypass operates in single switch and it has three positions - Normal, Interim and Bypass.

##### 13.3.1.1 Normal to Bypass

1. Rotate the MBP Switch (S1) from **NORMAL** to **BYPASS**. (Note: Do not stop at **INTERIM** position)
2. Switch **OFF** the DC power and/or disconnect batteries.

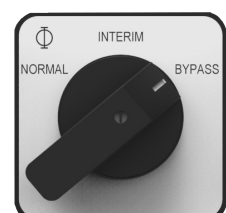

### 13.3.1.2 By-Pass to Normal

1. Switch **ON** the DC power and/or connect batteries.
2. Rotate the MBP Switch (S1) from **BYPASS** to **INTERIM**.  
(Wait until the modules turn on and synchronized, approximately 30-60 seconds).
3. Rotate the MBP Switch (S1) from **INTERIM** to **NORMAL**.

### 13.3.2 MBP - Three individual switches

In this model, manual bypass operates through three individual switches - S1 (Manual Bypass), S2 (AC out) and S3 (AC IN).

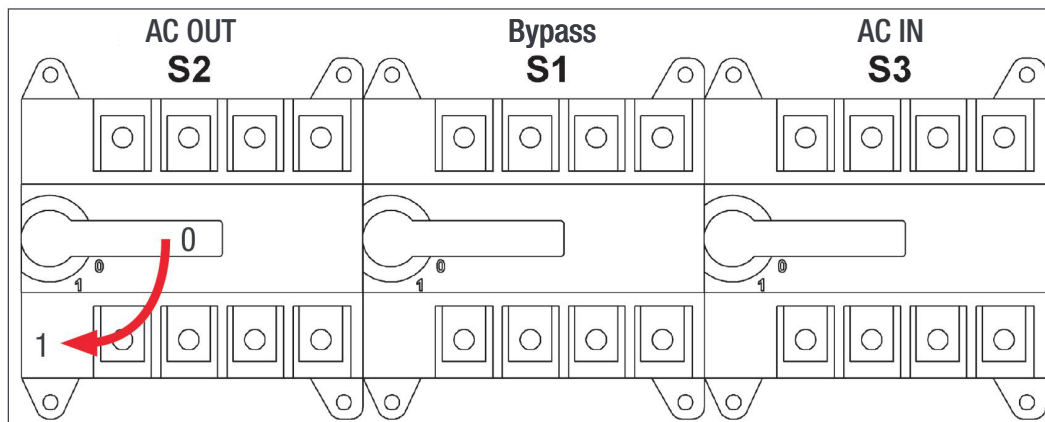

#### 13.3.2.1 Normal to By-Pass

1. Close the By-Pass switch S1, 0 to 1
2. Open the AC Out switch S2, 1 to 0
3. Open the AC IN switch S3, 1 to 0
4. Switch **OFF** the DC power and/or disconnect batteries

#### 13.3.2.2 By-Pass to Normal

1. Switch **ON** the DC power and/or connect batteries.
2. Close the AC IN switch S3, 0 to 1.  
(Wait until the modules turn on and synchronized, approximately 30-60 seconds).
3. Close the AC Out switch S2, 0 to 1.
4. Open the By-Pass switch S1, 1 to 0

## 14. Finishing

---

- Make sure that the sub-rack/cabinet is properly fixed to the cabinet/floor
- Make sure that the sub-rack/cabinet is connected to Ground.
- Make sure that all DC and AC input breakers are switched OFF.
- Make sure that all cables are according to recommendations and local regulations.
- Make sure that all cables are strained relieved.
- Make sure that all breakers are according to recommendation and local regulations.
- Make sure that DC polarity is according to marking.
- Re tighten all electrical terminations.
- Make sure that no inverter/controller positions are left open.
- Cover empty inverter positions with dummy cover.
- Make sure that the Remote ON/OFF is appropriately wired according to local regulations.
- Make sure that the point of AC supply meets local regulations.

## 15. Commissioning

---

The DC breaker is a protection device. Modules are plugged in a system and DC breaker is then engaged. Please make sure the corresponding DC breaker is engaged in the ON position. Failure to observe this rules will result not to have all module operating when running on DC and have module failure when AC input recover from fault condition.

Installation and commissioning must be done and conducted by trained people fully authorized to act on installation.

It is prohibited to perform any isolation test without instruction from manufacturer.

Equipments are not covered by warranty if procedures are not respected.

## 15.1 Check list

DATA	
Date	
Performed by	
Site	
System serial number	
Module serial numbers	
Inview Serial number	
ACTION	
	OK/ N.OK
Unplug all inverters except one inverter per phase (Just pull off the inverter from the shelf, to interrupt electrical contacts)	
Check the commercial AC before closing the AC input breaker.	
Switch ON the commercial AC	
Check if inverters are working (Green led)	
Check the DC power supply and switch ON the DC breakers	
Plug in all inverters one by one	
Check output voltage (on bulk output or on breaker)	
Check if inverters are working properly	
Check if system has no alarm (Disable the alarm if any)	
Read configuration file and review all parameters. Some parameters must be adapted according to the site (LVD, load on AC, AC threshold level)	
Switch OFF ACin and check if system is working on DC	
Switch ON ACin and check if system correctly transferred load on AC	
Switch OFF system and start on AC only	
Switch OFF system and start on DC only	
Check if display working properly (if this CANDIS option is present)	
Check if TCPIP working properly (if this option is present)	
Test on load (if available)	
ALARM	
Switch ON AC input and DC input and check that no alarm are present	
Pull out one inverter and check alarm according to redundancy	
Pull out two inverters and check alarm according to redundancy	
Switch OFF AC input (commercial power failure) and check the alarm according to the configuration	
Switch OFF DC input (DC power failure) and check that the alarm according to the configuration	
Check the different digital input according to the configuration (when used)	

## 16. Trouble Shooting and Defective Situations Fixing

### 16.1 Trouble Shooting

Inverter module does not power up:	Check AC input present and in range (AC breakers) Check DC input present and in range (DC breakers) Check that the inverter is properly inserted Remove inverter to verify that slot is not damaged, check connectors Check that module(s) is (are) in OFF state Check for loose terminations
Inverter system does not start:	Check that Inview is present and properly inserted Check remote ON/OFF terminal Check the configuration and setting Check threshold level
Inverter only run on AC or DC:	Check AC input present and in range (AC breakers) Check DC input present and in range (DC breakers) Check the configuration and setting Check threshold level(s)
No output power:	Check output breaker
All OK but I have alarm:	Check configuration file and correct No of modules Download/clear log file
No output alarm:	Mind the default time delay (UA: 60s, NUA: 30s) Check configuration file



## 17. Maintenance

---

Maintenance should be performed by properly trained people.

### 17.1 Access Inview S with Laptop

- Download system LOG FILE and save
  - Analyze log file and correct errors
- Download system CONFIGURATION FILE and save
  - Check/correct configuration file according to operation conditions
  - Check/correct alarm configuration
- Check module internal temperature for deviation between modules
  - Temperature deviation may indicate build up of dust. Clean the module by air suction blower or vacuum cleaner.
- Check module/system load
- Check/Correct inverter mapping (DC group/AC group/ Address)

### 17.2 Manual check

- Check voltages of AC input, DC input, AC output and DC output using the multi-meter
- Replace door filter if more dust is accumulated.
- Take a snap shot of the cabinet and site condition

### 17.3 Optional

- With an infrared camera check termination hot spots
  - Tighten terminations

### 17.4 Manual By-Pass

- Make sure AC input source is available during MBP operation. Otherwise the LOAD will be affected.

## 18. Defective modules

---

- A repair request should follow the regular logistics chain:  
End-user => Distributor => CE+T Power.
- Before returning a defective product, a RMA number must be requested through the <http://my.cet-power.com/extranet>. Repair registering guidelines may be requested by email at [repair@cet-power.com](mailto:repair@cet-power.com).
- The RMA number should be mentioned on all shipping documents related to the repair.
- Be aware that products shipped back to CE+T Power without being registered first will not be treated with high priority!

## 19. Service

---

### For Service

- Check Service Level Agreement (SLA) of your vendor. Most of the time they provide assistance on call with integrated service. If such SLA is in place, you must call their assistance first.
- If your vendor doesn't provide such assistance (\*) you may contact CE+T through [email: customer.support@cet-power.com](mailto:customer.support@cet-power.com)

(\*) CE+T will redirect your call to your vendor if he has such SLA in place.

## 20. Appendix

### 20.1 Mains connection, Single phase

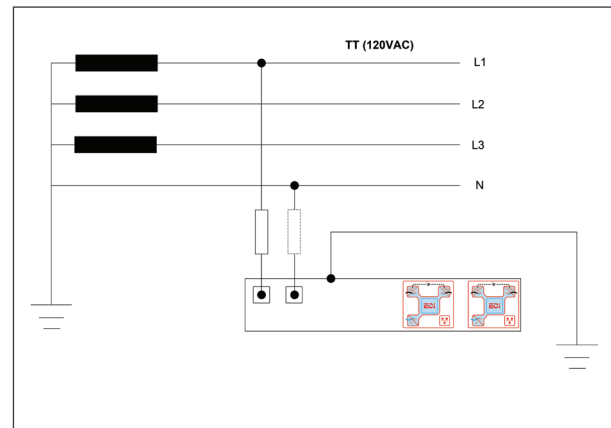
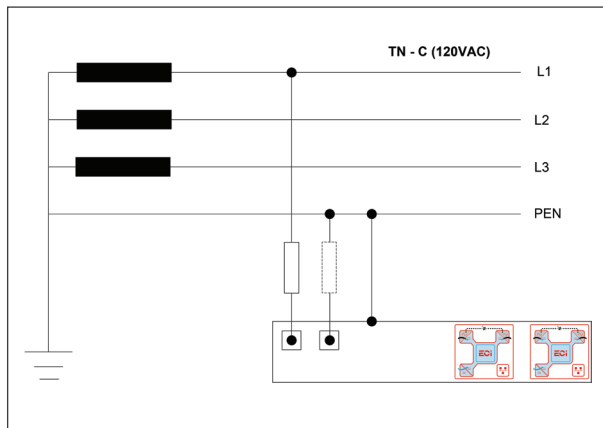
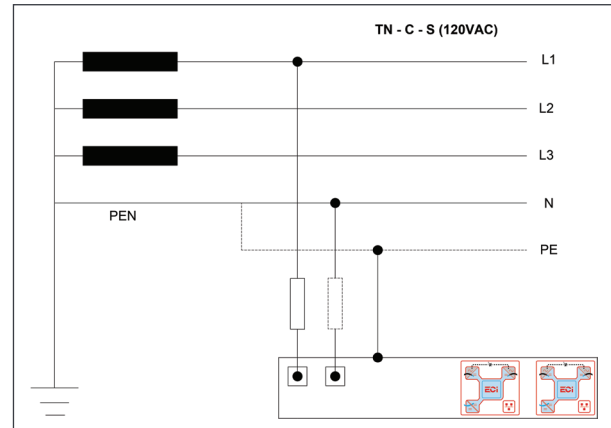
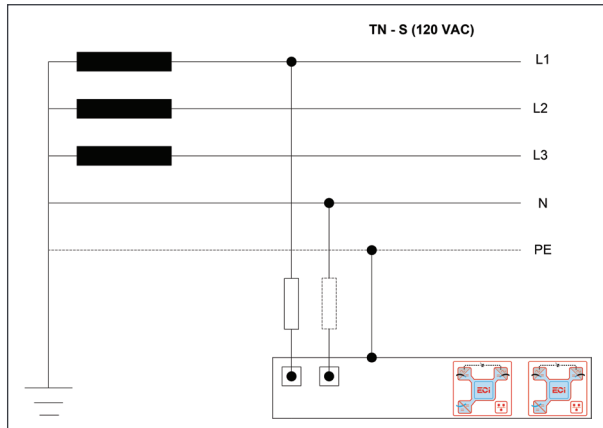

## 20.2 Mains connection, Three phases

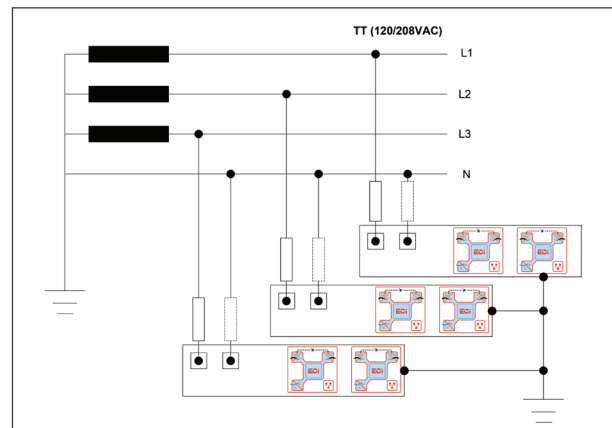
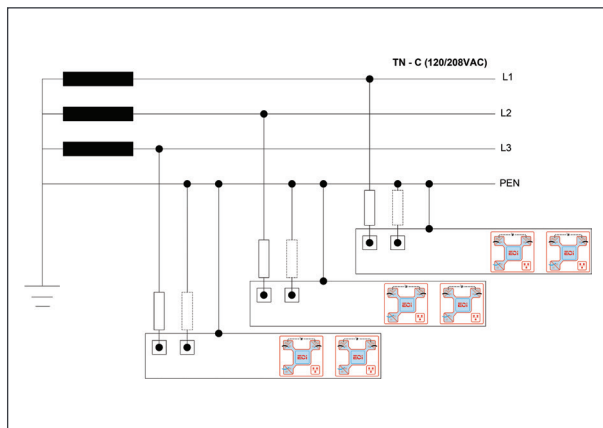
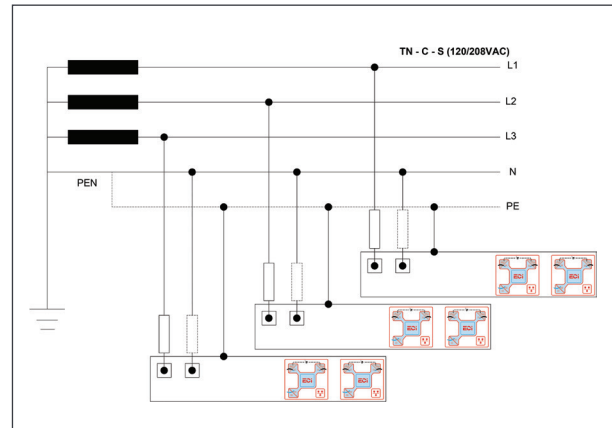
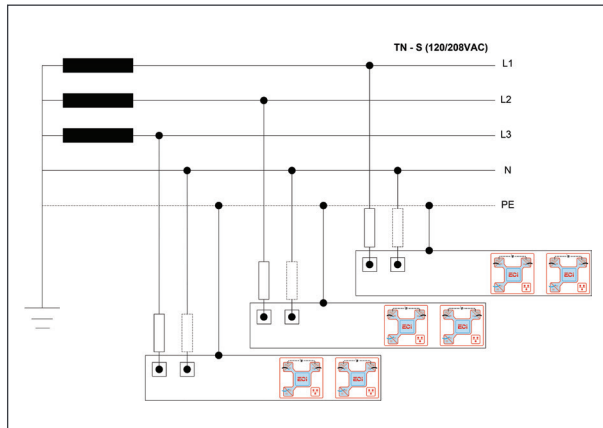

## 20.3 Bravo ECI - Dimensions

### 20.3.1 Module

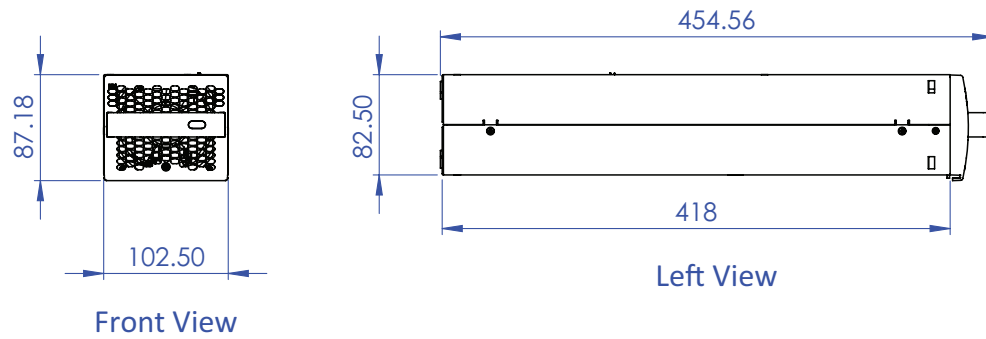

### 20.3.2 Shelf

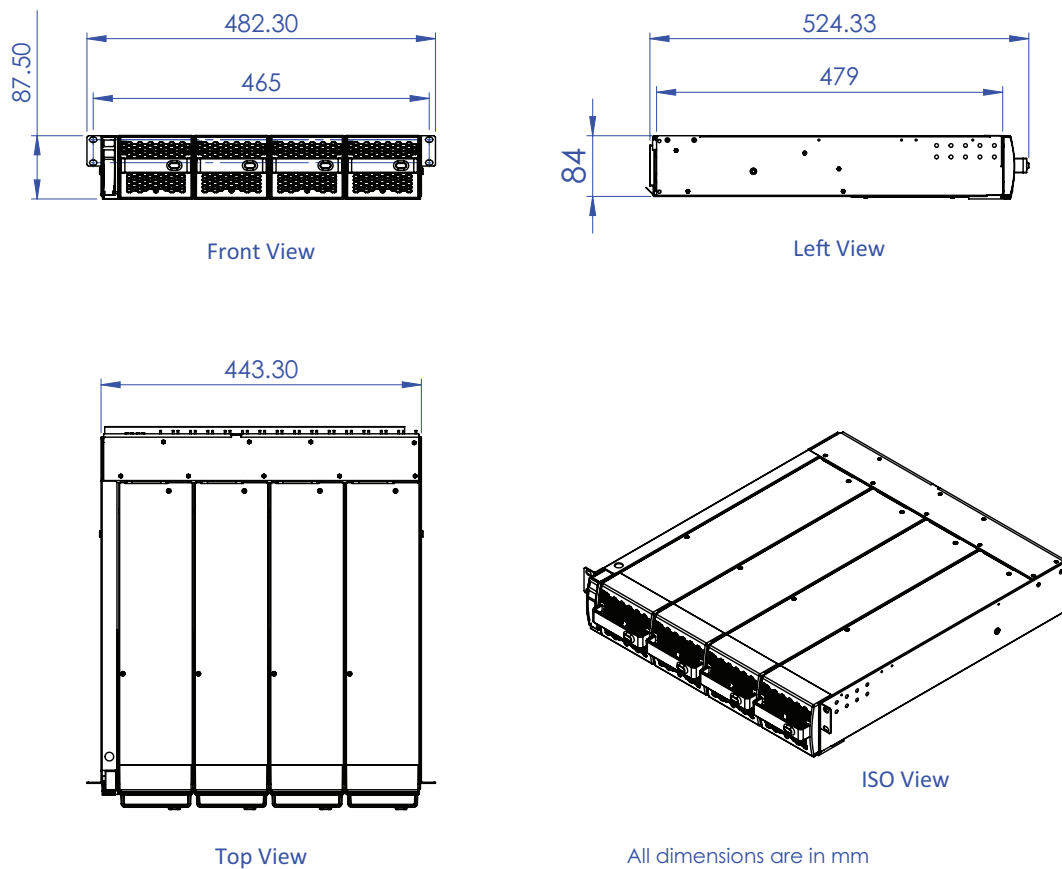

## 20.4 Inview S with MBB - Wiring diagram

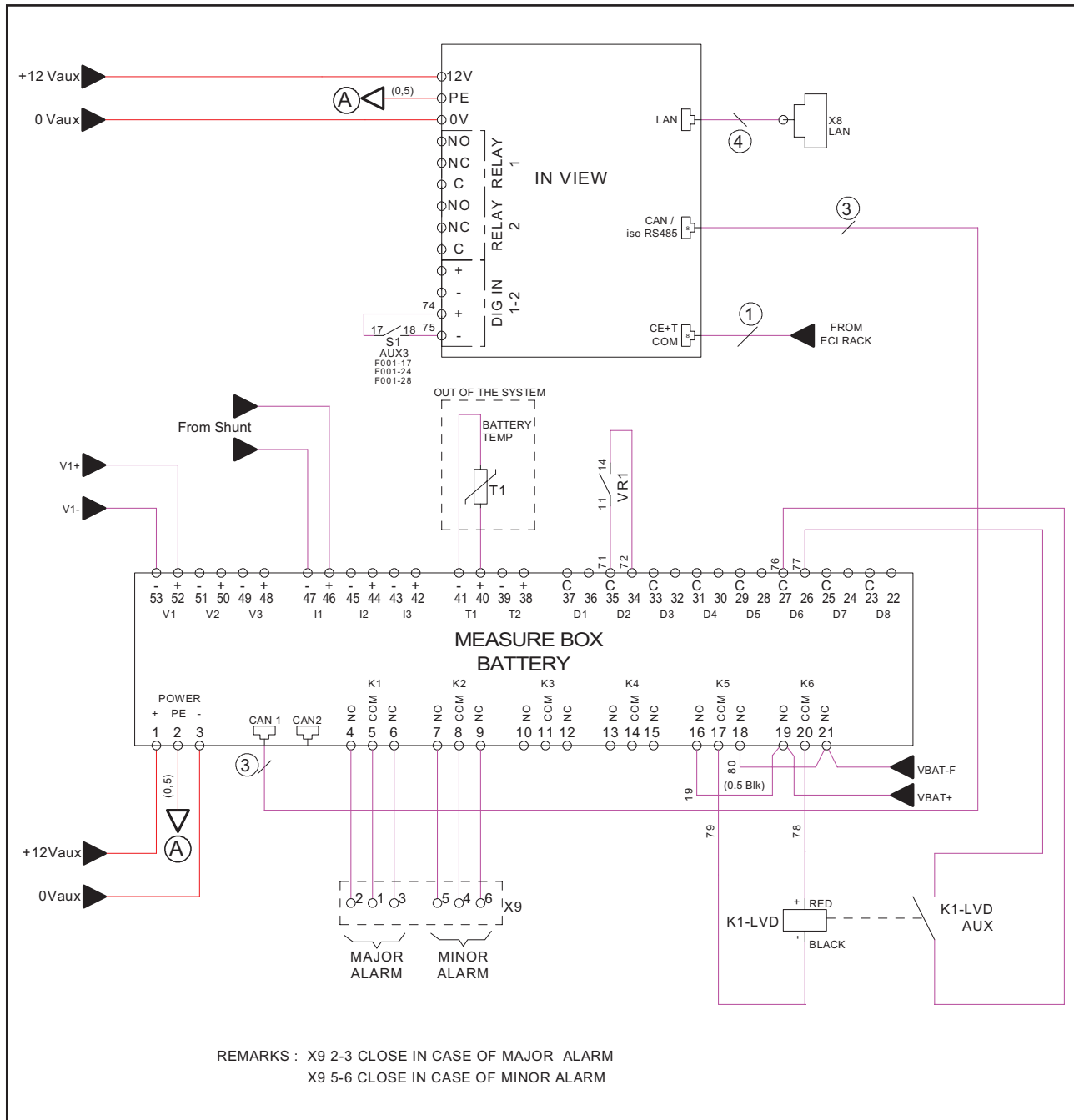

## 20.5 Modules - Parameter List

The below table is reference for 48 Vdc / 230 Vac converters. If it is other DC and AC voltages, enter the appropriate values.

Parameter	Description	Min	Default	Max	Unit
V DC in low start - dV (000)	Low DC Voltage where a higher value leads the DC/AC converter to re-start	390	440	610	dV
V DC in low transfer - dV (001)	Low DC Voltage where a lower value leads to transfer the load from DC IN to AC IN. Under this voltage peak-shaving is relaxed and battery discharge test is stopped.	390	390	610	dV
V DC in low stop - dV (002)	Low DC voltage where a lower value stops the DC/AC converter	390	390	610	dV
V DC in high start - dV (003)	High DC voltage where a higher value re-starts the DC/AC converter	390	580	610	dV
V DC in high transfer - dV (004)	High DC Voltage where a higher value leads to transfer the load from DC IN to AC IN	390	610	610	dV
V DC in high stop - dV (005)	High DC voltage where a higher value stops the DC IN converter. Value increased from sw 173 to 62 VDC	390	610	610	dV
V AC in low start - dV (006)	AC IN Voltage where a higher value leads the AC IN to start	1950	1950	1950	dV
V AC in low transfer - dV (007)	AC IN Voltage where a lower value leads to the transfer of the load from the AC IN to DC IN	1850	1850	1850	dV
V AC in low stop - dV (008)	AC IN Voltage where a lower value leads the AC IN converter to stops.  It is possible to step down to 150 Vac. In this case, the AC/DC converter will run at a lower power.  The converter DC/DC supply the rest (ONLY if DC is available, if not, there is a de-rating)	1820	1820	1820	dV
V AC in high start - dV (009)	AC IN Voltage where a lower value leads the AC IN converter re-start	2550	2550	2550	dV
V AC in high transfer - dV (010)	AC IN Voltage where a higher value leads to the transfer the load of the charge from the AC IN converter to the DC IN converter	2600	2600	2600	dV
V AC in high stop - dV (011)	AC IN Voltage where a higher value leads to stop the AC IN converter	2650	2650	2650	dV
F AC in low start - cHz (012)	Frequency where a higher value leads the outlet of the inverters trying to synchronize with AC IN	4700	4730	6300	cHz
F AC in low stop - cHz (013)	Frequency where a lower value leads the outlet of inverters stop to synchronize with AC IN	4700	4700	6300	cHz
F AC in high start - cHz (014)	Frequency where a lower value leads the inverters outlet to synchronize with AC IN	4700	5270	6300	cHz
F AC in high stop - cHz (015)	Frequency where a higher value leads the inverters outlet to stop to synchronize with AC IN	4700	5300	6300	cHz



Parameter	Description	Min	Default	Max	Unit
Free running frequency - cHz (016)	Set the Inverters system frequency. This frequency is used when the system is not synchronized on AC input.	-	5000	-	cHz
Out 1 phase shift - deg (018)	Phase displacement.	0	0	360	Deg
Out 2 phase shift - deg (019)		0	120	360	Deg
Out 3 phase shift - deg (020)		0	240	360	Deg
Out 4 phase shift - deg (021)		0	0	0	Deg
Out 5 phase shift - deg (022)		0	0	0	Deg
Out 6 phase shift - deg (023)		0	0	0	Deg
Out 7 phase shift - deg (024)		0	0	0	Deg
Out 8 phase shift - deg (025)		0	0	0	Deg
Out 1 nominal voltage - dV (026)	Set output voltage for each phase.	2000	2300	2450	dV
Out 2 nominal voltage - dV (027)		2000	2300	2450	dV
Out 3 nominal voltage - dV (028)		2000	2300	2450	dV
Out 4 nominal voltage - dV (029)		2000	2300	2450	dV
Out 5 nominal voltage - dV (030)		2000	2300	2450	dV
Out 6 nominal voltage - dV (031)		2000	2300	2450	dV
Out 7 nominal voltage - dV (032)		2000	2300	2450	dV
Out 8 nominal voltage - dV (033)		2000	2300	2450	dV
Short circuit voltage threshold - V (034)	Minimum Voltage Threshold where module considers that outlet is in short circuit.	80	80	200	V
Short circuit hold time - ds (035)	Time Duration when a module tries to eliminate the short-circuit existing on outlet. If the system is still in short-circuit after this time, the output will be stopped.	1	600	6000	ds
Input source - % (036)	Defines the priority source  0 - Feeding from AC IN has priority (converter AC/AC - EPC mode) default value.  100 - Feeding from DC has priority (converter DC/AC - On Line mode)	0	0	100	%
Synchronisation tracking speed (037)	The speed at which the module tries to synchronize the AC Out with AC IN. The lowest value will have the fastest synchronization.	-2	0	2	
Max power - % (038)	Maximum Power that module can supply	30	150	150	%
Max current - % (039)	Maximum Current that module can supply.	30	150	150	%
Max overload duration - s (040)	Maximum Time Duration when module can run with overload	0	15	15	s

Parameter	Description	Min	Default	Max	Unit
AC in mode (041)	Allows to open the AC IN inlet relay 0 - normal running in EPC mode. 1 - AC IN inlet relay is open and so the system is insulated from the Mains. This parameter can be set to 1 only if repartition is on DC (parameter 036 should be 100)	0	0	1	
Booster 10x I in (042)	Allow to inhibit the Booster option which generates a current of 10 In for 20ms in case of short-circuit (9 In for Nova inverter).	0	1	1	
Remote off disable AC in power (043)	This parameter change the attribution of the remote ON/OFF input. If parameter is 1, then, when system is in remote OFF position, output is not stopped and AC input is stopped instead.	0	0	1	
Reinjection allowed (044)	If this parameter is 1, the module is allowed to inject power in the grid with its AC input.	0	0	1	
External clock (045)	Records the "External Clock" mode configuration 0 - no protection in: phase drift is allowed. 1 - protection in: no phase drift allowed, stops the system after 1 minute. 2 - System stops immediately.	0	0	2	
Walk in mode - das (046)	The Walk-in mode allows the inverter to come back progressively on the AC priority source after an outage. Friendly use on Genset	0	0	12	
Triangle mode (047)	Defines the protection type for working on Delta load. 0 - Default setting, and no delta load protection 1 - The mode is active. If one output phase stops, the other phases will also stop.	0	0	1	
Airco mode (048)	When this mode is activated, the overload capabilities are moved from default value to 330% overload in current and power for maximum 900 ms.	0	0	1	
Start without supervision (049)	When this mode is activated, the module is able to start without Inview S.	0	1	1	
P DC max - W (050)	This feature allow to limit or reduce the INRUSH DC current when the system work on battery. To limit the current this configuration line should limit the inrush DC current. To allow for the high capability this inverter is build with extra capacitor running on 400VDC to provide the requested energy.	0	0	1	

Parameter	Description	Min	Default	Max	Unit
AC 1 stop power (051)	Stops the power of the corresponding AC group. The AC input of the modules of this AC group will then be used for synchronisation only, no power will be taken.	0	0	1	
AC 2 stop power (052)		0	0	1	
AC 3 stop power (053)		0	0	1	
AC 4 stop power (054)		0	0	1	
St module number (055)	NA	0	0	3	
St module redundancy (056)	NA	0	0	4	
Tus (057)	Mode TUS activation	0	0	1	
Tus modules number (058)	Number of TUS modules in the system (typically 2) -> number of tus seen by local supervision	0	0	24	
Tus sub sub system address (059)	address of the system on TUS bus -> address of local supervision which need to be different from other local supervisions	0	0	4	
Tus sub sub system output phase (060)	Output phase in TUS mode	0	0	11	
Tus sub system index (061)	System index in TUS mode (for example, if we have a A+B redundancy, this parameter is 1 for A systems, 2 for B systems)				
Number of tus sub sub system (062)	Number of systems connected on TUS bus	0	0	8	
Tus supply x supervision mode (063)	X TUS supply source	-	-	-	
Tus supply y supervision mode (064)	Y TUS supply source	-	-	-	
Tus sub sub system dc group (065)	DC group of the system in TUS mode	0	0	3	
V DC charger safe mode - cV (066)	DC voltage set point in SIERRA mode	5300	5400	5400	cV
P DC charger safe mode - W (067)	DC power setpoint in sierra mode (> 0 if battery discharge, <0 if battery charging)	0	-	2400	W
P AC peak shaving safe mode - W (068)	global peak-shaving (-1 if no peak-shaving)				
P AC max per phase safe mode - W (069)	Peak-shaving for each individual phase (-1 if no peak-shaving)				
Phase compensation (070)	Phase balancing	0	1	1	
Sierra mode (071)	Is module allowed to run in charger mode	0	1	1	
V DC low stop charger - cV (072)	Dc voltage under which charger is stopped	0	0	1	
Lvd mode (073)	If this mode is ON, module goes in low consumption mode 1 minute after it stops by Vdc LowStop	0	0	1	
Max V DC increment safe mode - cV (074)	Vdc set point rising speed when there is no supervision				

